

## About this Manual

We've added this manual to the Agilent website in an effort to help you support your product. This manual is the best copy we could find; it may be incomplete or contain dated information. If we find a more recent copy in the future, we will add it to the Agilent website.

## Support for Your Product

Agilent no longer sells or supports this product. Our service centers may be able to perform calibration if no repair parts are needed, but no other support from Agilent is available. You will find any other available product information on the Agilent Test & Measurement website, [www.tm.agilent.com](http://www.tm.agilent.com).

## HP References in this Manual

This manual may contain references to HP or Hewlett-Packard. Please note that Hewlett-Packard's former test and measurement, semiconductor products and chemical analysis businesses are now part of Agilent Technologies. We have made no changes to this manual copy. In other documentation, to reduce potential confusion, the only change to product numbers and names has been in the company name prefix: where a product number/name was HP XXXX the current name/number is now Agilent XXXX. For example, model number HP8648A is now model number Agilent 8648A.

---

# User's Guide

Publication number E3490-97003  
Third edition, August 1995

For Safety information, Warranties, and Regulatory information, see the pages behind the index.

© Copyright Hewlett-Packard Company 1994, 1995  
All Rights Reserved

---

## HP E3490A Software Probe

---

## HP E3490A Software Probe—At a Glance

The HP E3490A Software Probe provides a low-cost way to debug embedded software for processors which have on-chip debug features.

The HP E3490A Software Probe supports the Motorola CPU32 family of microprocessors, including the MC6833x, MC68340, and MC68360 microprocessors. Other processor families may also be supported by the time you read this.

### The target connection

The HP E3490A Software Probe connects to your target microprocessor via a processor family-specific cable. The cable plugs into a special connector on the target system. Flying leads can also be used to connect the HP E3490A Software Probe to the appropriate target signals.

### The host computer connection

The HP E3490A Software Probe can communicate with a host computer via a LAN connection (10 BASE-T or 10 BASE2).

It can also communicate with a host computer via an RS-232 serial connection.

### The configuration switches

Use the switches to configure communication to the host computer. There is a guide to these switches on the bottom of the HP E3490A Software Probe.

### The status LEDs

LEDs show the status of the power supply, the target system, and the connection to the host computer.

### Compatibility with other products

The HP E3490A Software Probe must be used with host-based software such as the HP Debugger/ Emulator. The debugging features available depend on the microprocessor's on-chip debug features and on the host user interface software being used.

### Differences Between an HP Emulator and the HP E3490A Software Probe

A debugger will behave just as if it is connected to an emulator, except:

- Trace functions are not available. You can use an HP logic analyzer if you need to trace bus-level activity.
- Emulation memory is not available.
- Like some HP emulators, the HP E3490A Software Probe has a built-in terminal interface, but it should only be used for configuration or troubleshooting.
- Some emulator features are not supported, such as supplying a clock or blocking resets while running in the monitor.

Because both an emulator and the HP E3490A Software Probe use BDM resources, you cannot use both at the same time.

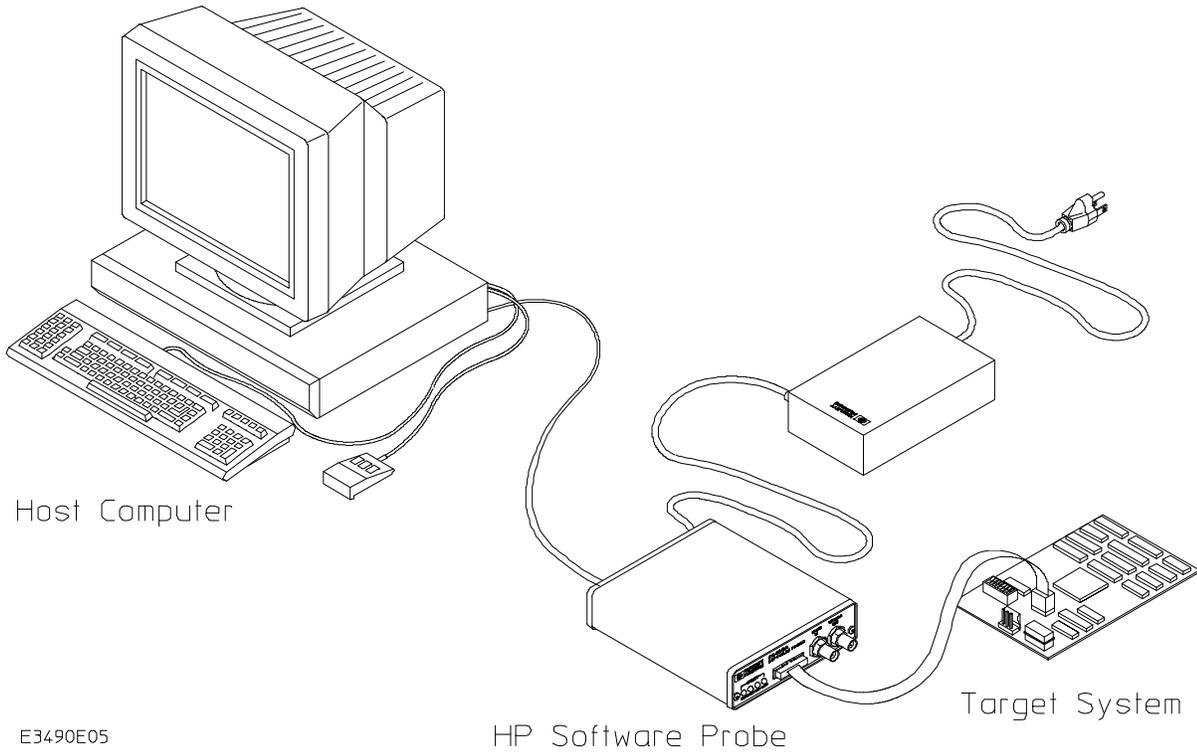

E3490E05



## **Part 1 Installation**

### **1 Connecting to the Host Computer**

Connecting the HP E3490A Software Probe to a Power Source 5

To choose a power cord 5

To connect the power cord and turn on the HP E3490 Software Probe 8

Setting Up a LAN Connection 9

To obtain an IP address 10

To configure LAN parameters using the built-in terminal interface 11

To configure LAN parameters using "ipconfig700" 14

To configure LAN parameters using BOOTP 16

To set the 10BASE-T configuration switches 18

To verify LAN communications 19

Setting Up a Serial Connection 20

To set the serial configuration switches 21

To connect a serial cable 21

To verify serial communications 23

Setting up the Host Software 24

To set up the 64700tab.net file 24

### **2 Connecting to the Target System**

To test the HP E3490A Software Probe 28

To connect to an 8-pin BDM connector 29

To connect to a 10-pin BDM connector 29

To connect to a CPU32 target using the flying leads 30

To set the BDM reset clock rate 31

## **Part 2 Using the HP E3490A Software Probe**

### **3 Starting a User Interface**

Using the HP Debugger/Emulator Interface 37

To use the "Getting Started" example 37

To start the Debugger/Emulator interface 38

Using the HP Real-Time C Debugger Interface 39

To use the "Getting Started" example 39

To configure the HP Real-Time C Debugger 39

### **4 Configuring the HP E3490A Software Probe Using the Debugger/Emulator Interface**

To configure the HP E3490A Software Probe 44

To set the processor type 45

Setting the Processor Clock Rate (BDM Communication Speed) 46

To set the processor clock rate (BDM communication speed) 47

To set the default clock rate if the processor clock rate is less than 8 MHz 48

Detailed information about processor clock rates 49

Configuring Internal Registers (SIM and EMSIM Registers) 51

To configure EMSIM values by copying SIM values 53

To manually define EMSIM values 54

To use a configuration file 54

Configuring Simulated IO 55

## **5 Configuring the HP E3490A Software Probe Using the Real-Time C Debugger**

To configure the HP E3490A Software Probe 59

To set the processor type 60

Setting the Processor Clock Rate (BDM Communication Speed) 61

To set the processor clock rate (BDM communication speed) 62

To set the default clock rate if the processor clock rate is less than 8 MHz 63

Detailed information about processor clock rates 64

Configuring Internal Registers (SIM and EMSIM Registers) 66

To copy EMSIM values to the SIM registers 68

To configure EMSIM values by copying SIM values 68

To manually define EMSIM values 69

To load EMSIM values from a configuration file 69

## **6 Using Internal Registers (EMSIM Registers)**

Using EMSIM Registers with the Debugger/Emulator Interface 73

To copy EMSIM registers to target SIM registers 73

To copy target SIM registers to EMSIM registers 73

To compare SIM and EMSIM registers 74

Using EMSIM Registers with the Real-Time C Debugger Interface 75

To copy EMSIM registers to target SIM registers 75

To copy target SIM registers to EMSIM registers 76

To compare SIM and EMSIM registers 76

Internal Representation of SIM and EMSIM Registers 77

## **7 Programming Target Flash Memory**

To program or erase a part using the HP Debugger/Emulator 82

To program or erase a part using the HP Real-Time C debugger 82

## **Part 3 Reference**

### **8 Designing a Target System**

Wiring the BDM Port 86

Enabling BDM 89

### **9 Specifications and Characteristics**

Processor Compatibility 92

Electrical Specifications 92

Environmental Specifications 94

### **10 Updating Firmware**

To order the software updates 97

To update firmware with "progflash" 98

To display current firmware version information 99

If the firmware doesn't appear to be updated 100

If there is a power failure during a firmware update 100

### **11 Solving Problems**

Status Lights 104

Problems with the LAN Interface 105

If you cannot verify LAN communication 105

If you have LAN connection problems 106

If you have LAN DLL errors 107

If the "POL" LED is lit 107

If it takes a long time to connect to the network 108

**Problems with the Serial Interface 109**

If you cannot verify RS-232 communication 109

If you have RS-232 connection problems with the MS Windows Terminal program 109

**Problems with the N-Wire Connection 111**

If a user interface behaves erratically 111

**Problems with Configuration 112**

If you have problems displaying some registers 112

If you have problems initializing some registers 112

**Problems with the Target System 113**

If boot area accesses fail 113

If the target system does not run 113

**Problems with the HP E3490A Software Probe Itself 114**

To run the power up self test 114

To execute the built-in performance verification test 115

If the data in ROM is corrupt 120

**Returning the HP E3490A Software Probe to Hewlett-Packard for Service 121**

To return the HP E3490A Software Probe to Hewlett-Packard 121

To obtain replacement cables 122

**Glossary****Index**



---

## Part 1

---

# Installation

---



---

1

---

# Connecting to the Host Computer

---

## Connecting to the Host Computer

To use the HP E3490A Software Probe you need to:

- Connect the HP E3490A Software Probe to a power source
- Connect the HP E3490A Software Probe to the host computer via a LAN or serial connection
- Set up the host software
- Connect the HP E3490A Software Probe to the target system (described in the next chapter)

If you plan to use the HP Debugger/Emulator interface on a UNIX workstation, you must use a LAN connection.

If you plan to use the HP Real-Time C Debugger interface on a PC, you can use a LAN or serial connection. If you use a LAN connection, you will need to set up a serial connection to set the IP address.

---

## Connecting the HP E3490A Software Probe to a Power Source

The HP E3490A Software Probe does not have an On/Off switch. To turn the HP E3490A Software Probe on or off, plug or unplug it from the power supply.

---

### To choose a power cord

The HP E3490A Software Probe is shipped from the factory with a power supply and cord appropriate for your country. You should verify that you have the correct power cable for installation by comparing the power cord you received with the HP E3490A Software Probe with the drawings under the "Plug Type" column of the following table.

If the cord you received is not appropriate for your electrical power outlet type, contact your Hewlett-Packard sales and service office.

---

**Warning**

---

Use only the supplied HP power supply and cord.  
Failure to use the proper power supply could result in electric shock.

---

**Caution**

---

Use only the supplied HP power supply and cord.  
Failure to use the proper power supply could result in equipment damage.

Connecting to the Host Computer  
**To choose a power cord**

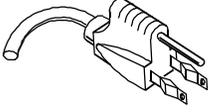
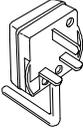
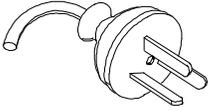
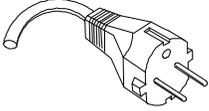
Plug Type	Cable Part No.	Plug Description	Length in/cm	Color
Opt 903 125V ** 	8120-1378	Straight * NEMA5-15P	90/228	Jade Gray
	8120-1521	90°	90/228	Jade Gray
Opt 900 250V 	8120-1351	Straight * BS136A	90/228	Gray
	8120-1703	90°	90/228	Mint Gray
Opt 901 250V 	8120-1369	Straight * NZSS198/ASC	79/200	Gray
	8120-0696	90°	87/221	Mint Gray
Opt 902 250V 	812001689	Straight * CEE7-Y11	79/200	Mint Gray
	8120-1692	90°	79/200	Mint Gray
	8120-2857	Straight (Shielded)	79/200	Coco Brown
<p>* Part number shown for plug is industry identifier for plug only.            Number shown for cable is HP part number for complete cable including plug.            ** These cords are included in the CSA certification approval for the equipment.</p>				

Connecting to the Host Computer  
**To choose a power cord**

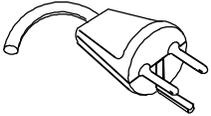
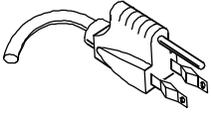
Plug Type	Cable Part No.	Plug Description	Length in/cm	Color
Opt 906 250V 	8120-2104	Straight * SEV1011	79/20	Mint Gray
	8120-2296	1959-24507 Type 12 90°	79/200	Mint Gray
Opt 912 220V 	8120-2957	Straight *DHCK107	79/200	Mint Gray
		90°	79/200	Mint Gray
Opt 917 250V 	8120-4600	Straight SABS164	79/200	Jade Gray
	8120-4211	90°	79/200	
Opt 918 100V 	8120-4753	Straight Miti	90/230	Dark Gray
	8120-4754	90°	90/230	
* Part number shown for plug is industry identifier for plug only. Number shown for cable is HP part number for complete cable including plug. ** These cords are included in the CSA certification approval for the equipment.				

---

## To connect the power cord and turn on the HP E3490 Software Probe

**1** Connect the power cord to the power supply and to a socket outlet.

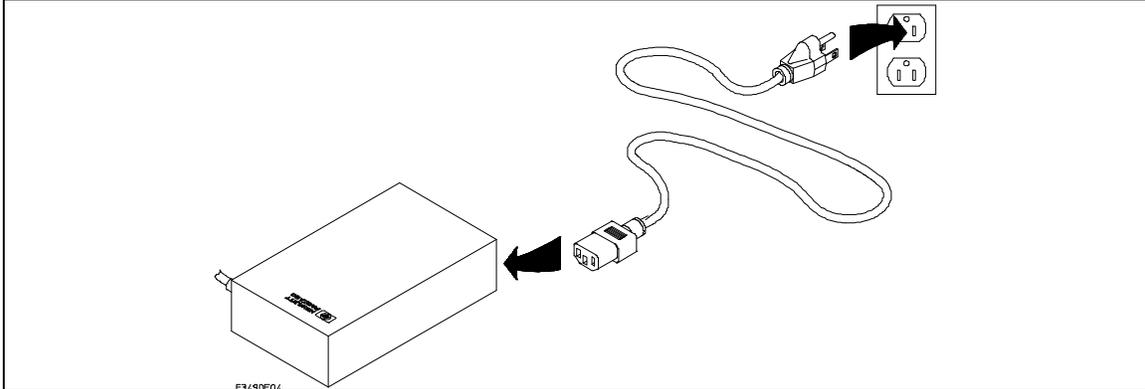

**2** Connect the 5V power cord to the back of the HP Software Probe.

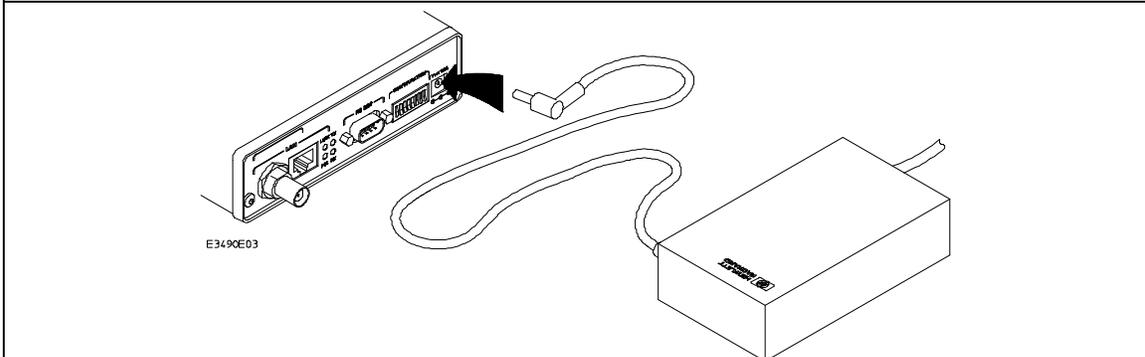

The power light on the target side of the HP Software Probe will be illuminated. The HP Software Probe does not have an On/Off switch.

## Setting Up a LAN Connection

The HP E3490A Software Probe has two LAN connectors:

- A BNC connector that can be directly connected to a IEEE 802.3 Type 10BASE2 cable (ThinLAN). When using this connector, the HP E3490A Software Probe provides the functional equivalent of a Medium Attachment Unit (MAU) for ThinLAN.
- An IEEE 802.3 Type 10BASE-T (StarLAN) connector.

Use either the 10BASE2 or the 10BASE-T connector. Do *not* use both. The HP E3490A Software Probe will not work with both connected at the same time.

You must assign an IP address (Internet address) to the HP E3490A Software Probe before it can operate on the LAN. You can also set other network parameters such as a gateway address. The IP address and other network parameters are stored in nonvolatile memory within the HP E3490A Software Probe.

The HP E3490A Software Probe automatically sets a subnet mask based on the subnet mask used by other devices on the network.

You can configure LAN parameters in any of the following ways:

- Using the built-in terminal interface. This is the most reliable method.
- Using ipconfig700. The ipconfig700 program is supplied with HP Debugger/Emulators which run on HP and Sun workstations.
- Using BOOTP. BOOTP is part of the HP-UX, SunOS, and Solaris operating systems.

## To obtain an IP address

**1 Obtain the following information from your local network administrator or system administrator:**

- An IP address for the HP E3490A Software Probe.
- The gateway address.

The gateway address is an IP address and is entered in integer dot notation. The default gateway address is 0.0.0.0, which allows all connections on the local network or subnet. If connections are to be made to workstations on other networks or subnets, this address must be set to the address of the gateway machine.

**2 Find out whether port numbers 6470 and 6471 are already in use on your network.**

The host computer interfaces communicate with the HP E3490A Software Probe through two TCP service ports. The default base port number is 6470. The second port has the next higher number (default 6471).

The default numbers (6470, 6471) can be changed if they conflict with some other product on your network. TCP service port numbers must be greater than 1024. If you change the base port, the new value must also be entered in the `/etc/services` file on the host computer. For example, you could modify the line:

```
hp64700 6470/tcp
```

To change the port numbers, see page 11. If you have already set the IP address, you can use a telnet connection instead of a serial connection to connect to the HP E3490A Software Probe.

**3 Write down the link-level address of the HP E3490A Software Probe.**

You will need this address if you use BOOTP or `ipconfig700` to set the IP address.

The link-level address (LLA) is printed on a label above the LAN connectors on the HP E3490A Software Probe. This address is configured in each HP E3490A Software Probe shipped from the factory and cannot be changed.

---

## To configure LAN parameters using the built-in terminal interface

- 1 Set configuration switches S1 through S4 to CLOSED, and set the other switches as appropriate for your serial interface.

Switch settings are printed on the bottom of the HP E3490A Software Probe. If you will use a baud rate of 9600 baud, set the switches like this:

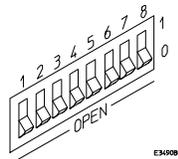

- 2 Connect an ASCII terminal (or terminal emulator) to the HP E3490A Software Probe's RS-232 port with a 9-pin RS-232 cable.

Complete instructions for setting up a serial connection begin on page 20.

- 3 Plug in the HP E3490A Software Probe's power cord. Press the terminal's <RETURN> key a couple times. You should see a "p>" or "R>" prompt.

At this point, you are communicating with the HP E3490A Software Probe's built-in terminal interface.

- 4 Display the current LAN configuration values by entering the **lan** command:

```
R>lan
lan is disabled
lan -i 0.0.0.0
lan -g 0.0.0.0
lan -p 6470
Ethernet Address : 08000903212f
```

The "lan -i" line shows the current IP address (IP address) of the HP E3490A Software Probe.

The Ethernet address, also known as the link level address, is preassigned at the factory, and is printed on a label above the LAN connectors.

- 5 Enter the following command:

```
lan -i <internet> [-g <gateway>] [-p <port>]
```

The lan command parameters are:

-i <internet> The IP address which you obtained from your network administrator.

Connecting to the Host Computer  
To configure LAN parameters using the built-in terminal interface

- g <gateway> The gateway address. Setting the gateway address allows access outside your local network or subnet.
- p <port> This changes the base TCP service port number.

The default numbers (6470, 6471) can be changed if they conflict with some other product on your network. TCP service port numbers must be greater than 1024. If you change the base port, the new value must also be entered in the /etc/services file on the host computer. For example, you could modify the line:

```
hp64700 6470/tcp
```

**6 Disconnect the power cord from the HP E3490A Software Probe, and connect the the HP E3490A Software Probe to your network.**

This connection can be made by using either the 10BASE-T connector or the 10BASE2 (BNC) connector on the HP E3490A Software Probe. Do not use both connectors at the same time.

**7 Set the configuration switches to indicate the type of connection that is to be made.**

Switch S1 must be set to OPEN, indicating that a LAN connection is being made.

Switch S5 should be 1 if you are connecting to the BNC connector:

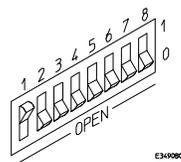

Switch S5 should be 0 if you are connecting to the 10BASE-T connector:

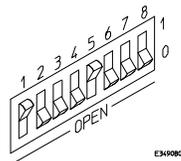

Set all other switches to CLOSED.

- 8 Connect the power cord to the HP E3490A Software Probe.**
- 9 Verify your HP E3490A Software Probe is now active and on the network. See "To verify LAN communications" on page 19.**

Once you have set a valid IP address, you can use the telnet utility to connect to the HP E3490A Software Probe, and use the lan command to change LAN parameters.

---

**Example**

For example, to assign an IP address of 192.6.94.2 to the HP E3490A Software Probe, enter the following command:

```
R>lan -i 192.6.94.2
```

The IP address and any other LAN parameters you change are stored in nonvolatile memory and will take effect the next time the HP E3490A Software Probe is powered off and back on again.

---

**See Also**

"Solving Problems," page 101, if you have problems verifying LAN communication.

---

## To configure LAN parameters using "ipconfig700"

If you are using an HP 9000 Series 300/400/700 computer or Sun SPARCsystem computer and you have installed the HP B1471 64700 Operating Environment software, you can configure the HP E3490A Software Probe's LAN parameters with the ipconfig700 command.

The ipconfig700 command sets the IP address and gateway address for the HP E3490A Software Probe. An IP address must be configured before a network interface connection can be made.

The ipconfig700 command cannot be used if your workstation is running a bootp daemon. If this is the case, use BOOTP to configure LAN parameters. To determine if BOOTP is enabled on your computer, see "To configure LAN parameters using BOOTP" in this chapter.

The following steps need to be taken when configuring the network parameters with ipconfig700.

- 1** Connect the the HP E3490A Software Probe to your network. This connection can be made by using either the 10BASE-T connector or the 10BASE2 BNC connector on the HP E3490A Software Probe.
- 2** Set the configuration switches to indicate the type of connection that is to be made.

Switch S1 must be set to OPEN, indicating that a LAN connection is being made. Switch S6 must bet set to OPEN, to allow programming of the LAN parameters.

Switch S5 should be 1 if you are connecting to the BNC connector:

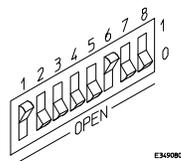

Switch S5 should be 0 if you are connecting to the 10BASE-T connector:

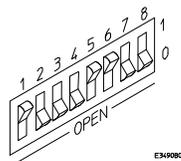

Set all other switches to CLOSED.

- 3** Turn ON power to the HP E3490A Software Probe.

- 4 Wait at least 20 seconds for the HP E3490A Software Probe to connect to the LAN.
- 5 Become the root user on the system from which you wish to configure the HP E3490A Software Probe.
- 6 Enter the following command:

```
ipconfig700 -l <link> -i <internet> [-g <gateway>]
```

The ipconfig700 parameters are:

- l <link> The link-level address. Enter any letters in the address in upper case.
- i <internet> The IP address.
- g <gateway> The gateway address.

If the ipconfig700 command is entered without any options, the program interactively prompts for the necessary information.

- 7 Set switch S6 back to CLOSED.
- 8 Verify your HP E3490A Software Probe is now active and on the network. See "To verify LAN communications" on page 19.

---

#### Example

If the link-level address on your HP E3490A Software Probe read 08000F090F30, and your system administrator gave you the IP address 192.35.12.6, you could enter the following command:

```
$ ipconfig700 -l 08000F090B30 -i 192.35.12.6 <RETURN>
```

Because no gateway address was entered, this value would default to 0.0.0.0. When the IP address is successfully programmed, ipconfig700 will display the HP E3490A Software Probe version information.

---

#### Limitations of ipconfig700

The ipconfig700 command generally will not work if:

- the workstation and the HP E3490A Software Probe are on different subnets, or
- a BOOTP daemon running elsewhere on your network is configured to respond to the link-level address of the HP E3490A Software Probe.

## To configure LAN parameters using BOOTP

Use this method only if your HP-UX workstation is already running bootpd, the BOOTP daemon. The ipconfig700 command does the same thing as BOOTP and is easier to use.

The BOOTP software is shipped with HP-UX version 8.0 or later. Your Hewlett-Packard Sales Engineer can provide the BOOTP software if you have an earlier version of HP-UX.

### 1 Make sure that your host computer supports BOOTP.

If the following commands yield the results shown below, your machine supports the BOOTP protocol.

```
$ grep bootp /etc/services
bootps      67/udp
bootpc      68/udp
$ grep bootp /etc/inetd.conf
bootps dgram udp wait  root /etc/bootpd  bootpd
```

If the commands did not yield the results shown, you must either add BOOTP support to your workstation or use a different method to configure the HP E3490A Software Probe LAN parameters.

### 2 Add an entry to the host BOOTP database file, /etc/bootptab. For example:

```
# Global template for options common to all HP 64700
emulators and Software Probes.
# Gateway addresses can be specified differently if
# necessary.

hp64700.global:\
    :gw=0.0.0.0:\
    :vm=auto:\
    :hn:\
    :bs=auto:\
    :ht=ether

# Specific emulator entry specifying hardware address
# (link-level address) and ip address.

hprobe.div.hp.com:\
    :tc=hp64700.global:\
    :ha=080009090B0E:\
```

```
:ip=192.6.29.31
```

In the example above, the "ha=080009090B0E" identifies the link-level address of the HP E3490A Software Probe.

The "ip=192.6.29.31" specifies the IP address that is assigned to the HP E3490A Software Probe.

The node name is "hprobe.div.hp.com".

For additional information about using bootpd, refer to the HP-UX man pages.

**3 Connect the the HP E3490A Software Probe to your network.**

This connection can be made by using either LAN connector on the HP E3490A Software Probe.

**4 Set the configuration switches to indicate the type of connection that is to be made.**

Switch S1 must be set to OPEN, indicating that a LAN connection is being made.

Switch S6 must be set to OPEN to enable BOOTP mode.

Switch S5 should be set to CLOSED if you are connecting to the BNC connector

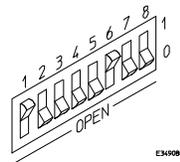

Switch S5 should be set to OPEN if you are connecting to the 10BASE-T connector.

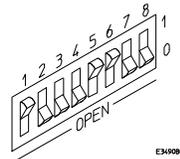

Set all other switches to CLOSED.

**5 Connect the power cord to the HP E3490A Software Probe.**

Verify that the power light stays on after 10 seconds.

The IP address will be stored in EEPROM.

**6 Set switch S6 back to CLOSED.**

Do this so that the HP E3490A Software Probe does not request its IP address each time power is cycled. The IP address is stored in EEPROM, so BOOTP does not need to be run again. Leaving this switch on will result in slower performance, increased LAN traffic, and even failure to power up (if the BOOTP server becomes inactive).

- 7 Verify your HP E3490A Software Probe is now active and on the network. See "To verify LAN communications" on page 19.

---

## To set the 10BASE-T configuration switches

Set switches S7 and S8 to CLOSED unless one of the following conditions is true:

- **If the LAN cable exceeds the standard length, set switch S7 to OPEN.** The HP E3490A Software Probe has a switch-selectable, twisted-pair receiver threshold. With switch S7 set to OPEN, the twisted-pair receiver threshold is lowered by 4.5 dB. This should allow you to use cable lengths of up to about 200 meters. If you use a long cable, you should consult with your LAN cabling installer to ensure that:
  - The device at the other end of the cable has long cable capability, and
  - The cable is high-grade, low-crosstalk cable with crosstalk attenuation of greater than 27.5 dB.

When switch S7 is set to CLOSED, the LAN port operates at standard 10BASE-T levels. A maximum of 100 meters of UTP cable can be used.

- **If your network doesn't support Link Beat integrity checking or if the HP E3490A Software Probe is connected to a non 10BASE-T network (such as StarLAN) set this switch to LINK BEAT OFF (0 or OPEN).** In normal mode (switch S8 set to CLOSED), a link integrity pulse is transmitted every 15 milliseconds in the absence of transmitted data. It expects to receive a similar pulse from the remote MAU. This is the standard link integrity test for 10BASE-T networks. If your network doesn't support the Link Beat integrity checking or if the Software Probe is used on a non 10BASE-T network (such as StarLAN) set this switch to LINK BEAT OFF (OPEN).

---

### Note

Setting switch S8 to OPEN when Link Beat integrity checking is required by your network will cause the remote MAU to disable communications.

---

## To verify LAN communications

- 1 Verify your HP E3490A Software Probe is now active and on the network by issuing a **telnet** to the IP address.

This connection will give you access to the HP E3490A Software Probe's built-in terminal interface.

- 2 To view the LAN parameters, enter the **lan** command at the terminal interface prompt.

- 3 To exit from this telnet session, type <CTRL>D at the prompt.

The best way to change the HP E3490A Software Probe's IP address, once it has already been set, is to telnet to the HP E3490A Software Probe and use the terminal interface **lan** command to make the change. Remember, after making your changes, you must cycle power or enter a terminal interface **init -p** command before the changes take effect. Doing this will break the connection and end the telnet session.

### If You Have Problems

If you encounter problems, refer to the "Problems" chapter (page 101).

---

#### Example

```
$ telnet 192.35.12.6

R>lan
lan is enabled
lan -i 192.35.12.6
lan -g 0.0.0.0
lan -p 6470
Ethernet Address : 08000F090B30
```

## Setting Up a Serial Connection

To set up a serial connection, you will need to:

- Set the serial configuration switches
- Connect the HP E3490A Software Probe to the RS-232 interface
- Connect a serial cable between the host computer and the HP E3490A Software Probe
- Verify communications

### **Serial connections on a workstation**

You should not use a serial connection on a workstation, except to set LAN parameters.

If you are using a UNIX workstation as the host computer, you need to use a serial device file. If a serial device file does not already exist on your host, you need to create one. Once it exists, you need to ensure that it has the appropriate permissions so that you can access it. See the system documentation for your workstation for help with setting up a serial device.

### **Serial connections on a PC**

Serial connections are supported on PCs. You must use hardware handshaking if you will use the serial connection for anything other than setting LAN parameters.

If you are using a PC as the host computer, you do not need to set up any special files.

---

## To set the serial configuration switches

- 1 Set switch S1 to CLOSED (RS-232).
- 2 Set switches S2-S4 to CLOSED.
- 3 Set switch S5 to CLOSED (HW HANDSHAKE ON) if your serial interface uses the DSR:CTS/RTS lines for flow control. Set S5 to OPEN (HW HANDSHAKE OFF) if your serial interface uses software flow control (XON/XOFF).  
If your serial interface supports hardware handshaking, you should use it (set switch S5 to CLOSED). Hardware handshaking will make the serial connection much more reliable.
- 4 Set switches S6-S8 for the baud rate you will use. These switch settings are listed on the bottom of the HP E3490A Software Probe.  
The higher baud rates may not work reliably with all hosts and user interfaces. Make sure the baud rate you choose is supported by your host and user interface.

---

### Example

To use a baud rate of 9600 baud, set the switches as follows:

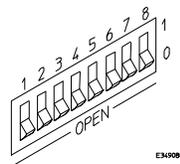

---

## To connect a serial cable

---

### CAUTION

Use a grounded, shielded cable. If the cable is not shielded, or if the cable is not grounded at the serial controller, the HP E3490A Software Probe may be damaged by electrostatic discharge.

- 1 Connect an RS-232C modem cable from the host computer to the HP E3490A Software Probe.  
The recommended cable is HP part number C2932A. This is a 9-pin cable with one-to-one pin connections.

## Connecting to the Host Computer To connect a serial cable

If you want to build your own RS-232 cable, follow the pinout shown in the following figure:

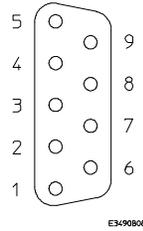

---

### Serial Cable Pinout

---

Pin Number	Signal	Signal Description
1	DCD	Data Carrier Detect (not used)
2	TD	Transmit Data (data coming from HP E3490A Software Probe)
3	RD	Receive Data (data going to HP E3490A Software Probe)
4	DTR	Data Terminal Ready (not used)
5	GND	Signal Ground
6	DSR	Data Set Ready (Output from HP E3490A Software Probe)
7	RTS	Request to Send (Input to HP E3490A Software Probe)
8	CTS	Clear to Send (connected to pin 6)
9	RING	Ring Indicator (not used)

---

## To verify serial communications

### 1 Start a terminal emulator program on the host computer.

If you are using a PC, the Terminal application in Microsoft Windows will work fine.

If you are using a UNIX workstation, you can use a terminal emulator such as cu or kermit.

### 2 Plug the power cord into the HP E3490A Software Probe.

When the HP E3490A Software Probe powers up, it sends a message (similar to the one that follows) to the serial port and then displays a prompt:

```
Copyright (c) Hewlett-Packard Co. 1987
All Rights Reserved.  Reproduction, adaptation, or translation without prior
written permission is prohibited, except as allowed under copyright laws.
```

```
HPE3499A Series Emulation System
Version:  A.05.00 04Aug94
Location:  Generics
```

```
HPE3490A Motorola CPU32 BDM Emulator
Version:  A.01.00 02Aug94
```

R>

The version numbers may be different for your HP E3490A Software Probe.

### 3 Press the Return or Enter key a few times.

You should see a prompt such as "R>" or "p>".

**See Also** "Problems with the Serial Interface," page 109.

## Setting up the Host Software

The HP E3490A Software Probe requires the use of user interface software on your host computer. Before you can use this software, you may need to configure some communication parameters:

- If you will be using an HP Debugger/Emulator on a workstation, you can set up the 64700tab.net file to give the HP E3490A Software Probe a "logical name" as you would for an emulator.
- If you are using the HP Real-Time C Debugger on a PC, you do not need to set up any files.
- If you are using another interface, such as a third-party debugger, check the interface documentation to see if you need to configure the LAN address or other communication parameters.

---

### To set up the 64700tab.net file

This step is optional. When you start a Debugger/Emulator interface, you need to specify the name or the IP address of the HP E3490A Software Probe to which it should connect. If you do not set up the 64700tab.net file, you will need to type the IP address (or an IP alias set in the /etc/hosts file) every time you start the Debugger/Emulator.

- 1** If you have not already installed the HP Debugger/Emulator software on your workstation, do so now.
- 2** Make up a *logical name* for the HP E3490A Software Probe.  
You will use this name to identify the HP E3490A Software Probe whenever you start the user interface software. This name can be any easy to remember name, perhaps a unique name for the target or processor.
- 3** Find the IP address of the HP E3490A Software Probe.

This is the address you set in the "Setting Up a LAN Connection" section of this chapter.

**4 Edit the `/usr/hp64000/etc/64700tab.net` file and add a line with the following format:**

```
lan: <logical_name> <processor_type> <connection_info>
```

<logical\_name>

The logical name chosen in step 2.

<processor\_type>

A general classification of the processor type. For the HP E3490A Software Probe, the processor\_type must be "cpu32\_bdm" or "\*".

<connection\_info>

The IP address of the HP E3490A Software Probe.

The 64700tab.net file defines the LAN connection to the target. The 64700tab.net file also defines the type of processor which the HP E3490A Software Probe should present to the Debug Environment.

The 64700tab.net file is located in the directory \$HP64000/etc (/usr/hp64000/etc by default).

---

**Example**

Here is an example line from `/usr/hp64000/etc/64700tab.net` for a 68332 processor connected to an HP E3490A Software Probe called "myprobe":

```
lan: my332 * myprobe
```

If you did not set up the "myprobe" alias in the `/etc/hosts` file, you could use its IP address:

```
lan: my332 * 192.35.12.6
```

The logical name of this HP E3490A Software Probe is "my332". You would use the name "my332" whenever you started a debugger interface.

---

Connecting to the Host Computer  
To set up the 64700tab.net file

---

2

---

## Connecting to the Target System

## Connecting to a Target System

The following cables are provided with the HP E3490A Software Probe:

- An 8-pin cable (HP part number E3490-61601)
- A 10-pin cable (HP part number E3490-61602)
- A 10-wire flying lead cable (HP part number E3490-61603)

The wide (20-pin) end of the cable plugs into the HP E3490A Software Probe; the other end connects to microprocessor signals on your target system.

A self-test connector (HP part number E3490-61604) is also provided.

---

### To test the HP E3490A Software Probe

- 1** Check that the self-test connector is plugged into the HP E3490A Software Probe.
- 2** Run the performance verification test described on page 115.
- 3** Remove the self-test connector.

If this is the first time you have used the HP E3490A Software Probe, you should run the built-in performance verification test before you connect to a target system.

---

## To connect to an 8-pin BDM connector

---

### CAUTION

Be careful to orient the connector as shown below. If the connector is rotated, your target system or the HP E3490A Software Probe may be damaged.

- 1 Check that the connector on your target system is wired as described in "Designing a Target System" (page 86).
- 2 Plug the wide end of the cable into the HP E3490A Software Probe.
- 3 Plug into the target system with the cable with the red wire toward pin 1 of the connector.

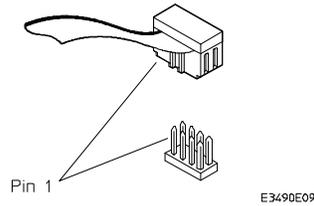

---

## To connect to a 10-pin BDM connector

---

### CAUTION

Be careful to orient the connector as shown below. If the connector is rotated, your target system or the HP E3490A Software Probe may be damaged.

- 1 Check that the connector on your target system is wired as described in "Designing a Target System" (page .86)
- 2 Plug the wide end of the cable into the HP E3490A Software Probe.
- 3 Plug into the target system with the cable with the red wire toward pin 1 of the connector.

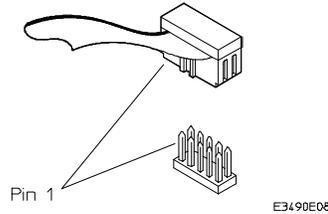

If you use the 10-pin cable on an 8-pin connector, pins 1 and 2 of the cable should be the ones which are not connected. Connect pin 3 of the cable to pin 1 of the target connector.

---

## To connect to a CPU32 target using the flying leads

Small SMT-compatible grabbers are included to help connect the flying leads to the target system. The ends of the flying leads will also fit onto the standard 0.025 inch pins on most probing clips.

- 1 Locate the BDM signals on your target system.
- 2 Connect the leads as shown in the following table:

---

### CPU32 Flying Lead Connections

---

Color	Signal
Brown	$\overline{DS}$ or not connected
Red	$\overline{BERR}$ or not connected
Orange	Ground
Yellow	BKPT/DSCLK
Green	Ground
Blue	$\overline{FREEZE}$
Violet	$\overline{RESET}$
Gray	IFETCH/DSI
White	$V_{DD}$
Black	$\overline{IPIPE/DSO}$

Connect  $\overline{DS}$  and  $\overline{BERR}$  if you want the HP E3490A Software Probe to terminate "hung" bus cycles.

- 3 Connect the cable to the HP E3490A Software Probe.

---

## To set the BDM reset clock rate

- If your target system runs at a default clock rate greater than or equal to 8 MHz, set switch S2 to CLOSED.

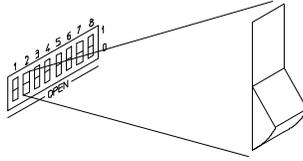

- If your target system runs at a default clock rate less than 8 MHz but greater than 131 kHz, set switch S2 to OPEN.

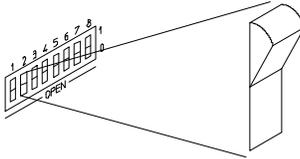

The target system default clock rate is the rate used when the target comes out of reset, and before a higher rate is begun by setting clock multiplier or clock divider values.

### See Also

"Setting the Processor Clock Rate" on page 46 for more information about BDM clock rates.



---

## Part 2

---

# Using the HP E3490A Software Probe

---



---

3

---

## Starting a User Interface

---

## Starting a User Interface

The HP E3490A Software Probe requires that you use a user interface program, such as a debugger, on your host computer.

You can use one of the following user interfaces:

- On an HP or Sun workstation, you can use the HP Debugger/Emulator.
- On a PC, you can use the HP Real-Time C Debugger.
- You can also use third-party (non-HP) interfaces which have been adapted for use with the HP E3490A Software Probe.

---

**Note**

---

You *must* use a host user interface program with the HP E3490A Software Probe.

Although built-in commands exist, they are not documented or supported. A small set of built-in commands is supplied, however, to help you configure LAN parameters.

---

## Using the HP Debugger/Emulator Interface

The HP Debugger/Emulator interface is a graphical debugger which runs on HP and Sun workstations.

The HP Debugger/Emulator interface uses menus and dialogs which make it easy to do things like download code, configure chip selects and registers, or step through your code. Using the debugger, you can view assembly-level instructions, C or C++ statements, and high-level variables and data structures.

---

### To use the "Getting Started" example

The "Getting Started" example is part of the Debugger/Emulator *User's Guide*.

**1 Set up a Motorola BCC demo board.**

If you use a Motorola BCC (68332) demo board, you will not need to recompile the demo files. If you want to use another target system, you must recompile the demo files for that processor.

**2 Follow the instructions given in the "Getting Started" chapter of the Debugger/Emulator *User's Guide*, with the following exceptions:**

Instead of an emulator name, use the name you assigned to the HP E3490A Software Probe in the hp64000tab.net file (page 24).

Use the demo directory \$HP64000/demo/debug\_env/hpE3490.

Skip any sections that discuss the "trace" function.

## To start the Debugger/Emulator interface

**1** At the operating system prompt, type

```
db68k -e <logical_name> &
```

The <logical\_name> is the LAN address or logical name you assigned to the HP E3490A Software Probe in the "Connecting to the Host Computer" chapter.

When the debugger starts, it will reset the processor then put the processor into background mode. If the initial stack pointer and program counter point to memory which is inaccessible, the debugger may take a long time to start up, or it may not start at all. If this happens, see page 113.

**2** Configure the HP E3490A Software Probe as described in the chapter titled "Configuring the HP E3490A Software Probe" on page 42.

**3** Load an executable file as described in the Debugger/Emulator *User's Guide*.

---

## Using the HP Real-Time C Debugger Interface

The HP Real-Time C Debugger interface is a graphical debugger which runs as an MS Windows application on a personal computer.

---

### To use the "Getting Started" example

- Follow the instructions given in the *Real-Time C Debugger User's Guide* for your processor.

---

### To configure the HP Real-Time C Debugger

- 1 Select **Settings**→**Emulator Config** from the menu bar.
- 2 Configure the processor clock rate.
- 3 Configure other items as needed.

#### See Also

For more information on using the configuration dialog, see the Real-Time C Debugger *User's Guide* or the on-line help.

Starting a User Interface  
**To configure the HP Real-Time C Debugger**

# 4

---

## Configuring the HP E3490A Software Probe Using the Debugger/Emulator Interface

---

## Configuring the HP E3490A Software Probe Using the Debugger/Emulator Interface

This chapter tells you how to configure the HP E3490A Software Probe using the HP Debugger/Emulator interface on a workstation.

The HP E3490A Software Probe supports only those features that are common on all the processors in the CPU32 family. Additional processor specific features and capabilities are supported through the use of user configurable parameters. These parameters may be customized for specific target systems and saved in configuration files for future use.

### **What can be configured**

The configurable parameters and their default values are:

- The target processor type.  
Default = 683xx
- The target processor clock rate (determines BDM communication speed).  
Default: ≥8 MHz if configuration switch #2 is CLOSED.  
Default: ≥131 kHz if configuration switch #2 is OPEN.
- Initial values for memory mapped registers in internal modules  
Default: Memory-mapped registers are not defined
- Simulated I/O setup and activation  
Default: off

### **What happens when a configuration is applied**

When a configuration is applied to HP E3490A Software Probe, the following events occur:

- 1** The target is reset.
- 2** The BDM communication speed is set to the rate based on the default target processor clock rate.
- 3** The target processor enters the BDM monitor.
- 4** The emulation copies of the SIM registers (specified in the configuration) are loaded into the target SIM.
- 5** The BDM communication speed is set to the rate based on the value configured as the target processor clock rate.

---

## To configure the HP E3490A Software Probe

Use one of the following ways to configure the HP E3490A Software Probe:

- **Start a user interface without specifying a configuration file.**  
In this case the HP E3490A Software Probe is initialized with a default configuration.
- **Start a user interface, specifying a configuration file.**  
In this case, the HP E3490A Software Probe is initialized with the values in the configuration file. The configuration file must have been created by saving a configuration in a user interface session.

---

### Example

```
db68k -C My_config -e logical_name
```

where My\_config is a file saved from a previous debugging session.

---

- **Modify the configuration from within the user interface.**  
When a user interface is started, the HP E3490A Software Probe is always configured from a default file or from user specified configuration file. This initial configuration can be modified from within the user interface by modifying the configuration values or by loading a new configuration file.  
To modify the configuration, choose **Modify→Emulator Config...** Now select the various sections, modify the setting, and finally use **Apply to Emulator** to apply the new setting to the emulator.  
To load a new configuration, select **File→Load Config** from the menu bar.

The configuration is also applied to the HP E3490A Software Probe when the target processor is reset while it is running in the BDM monitor.

---

## To set the processor type

- 1 In the Emulator Configuration dialog box, select **General Items**.
- 2 Position the mouse pointer in the Processor field.
- 3 Enter the processor type.  
To see a list of processor types supported, press the F1 key.
- 4 Click on the **OK** button.

---

### Note

Once you have set the processor type, you cannot change it unless you exit (**Exit Released**) and restart the debugger.

If you enter the wrong processor type and have not yet applied the configuration, you can exit the configuration dialog box and start over with step 1 above.

---

The default value for the processor configuration item is 683xx. With this value, the HP E3490A Software Probe can provide direct access to all the registers defined in the CPU32 architecture programming model but will not have direct access to memory mapped registers in the processor's internal modules.

If a processor is specified, the HP E3490A Software Probe will have knowledge of on-chip peripheral registers and SIM registers and will allow display and modification from the user interface. For example, when 68332 is selected as the processor type, the interface will support direct access to the SIM, the QSM, the TPU, and the TPURAM registers.

The initially supported processor types are 683xx, 68331, 68332, 68336, 68340, and 68360.

The HP E3490A Software Probe does not have explicit support for all CPU32 processors. When using a member of the CPU32 family that is not explicitly supported it may be possible to select a processor that is a formal subset of the unsupported processor. This will provide direct access to all of the internal memory mapped registers that are common. Since the registers in the internal modules are memory mapped, registers in unsupported CPU32 processors are also accessible through the memory commands. For example, on a 68332, SIM registers can be accessed at memory locations 7FFA00 to 7FFA7F or FFFA00 to FFFA7F.

---

## Setting the Processor Clock Rate (BDM Communication Speed)

The HP E3490A Software Probe needs to be configured to communicate at a rate which is compatible with your target processor clock rate. This can be done through your user interface software.

If your target processor runs at less than 8 MHz after power-up, you will also need to set a configuration switch.

## To set the processor clock rate (BDM communication speed)

- 1** In the Emulator Configuration dialog box, select **General Items**.
- 2** Select a Processor Clock Rate.
- 3** Click on the **OK** button.

The processor clock rate configuration parameter is used to specify the maximum rate that the HP E3490A Software Probe can communicate with the target processor through the BDM port. This maximum communication rate is based upon the target processor type and the target processor clock rate. The maximum communication rate directly impacts the performance of downloading files through the HP E3490A Software Probe and the intrusion time when polling for simulated I/O. Running at a rate slower than the maximum does not prevent correct operation.

The default value for the processor clock rate configuration parameter is determined by the setting of configuration switch S2. In the Normal (CLOSED) position this parameter is set to "greater than or equal to 8 MHz". In the OPEN position this parameter is set to "greater than or equal to 131 kHz".

Most target systems run with a Processor Clock Rate of 8 MHz or above and so will function properly using the default value. For correct operation in target systems that run slower than 8 MHz, the default clock rate must be set to "greater than or equal to 131 kHz" by setting switch S2 to OPEN.

The best performance for the HP E3490A Software Probe usually requires changing the communication rate from the default value. Set the "Processor Clock Rate" parameter to the highest rate that is equal to or less than the target running clock rate. If using the internal clock synthesizer, set the EMSYNCR (EMulator copy of the SYNthesizer Control Register, SYNCR) to the same value as set by the initialization code. (See "Configuring Internal Registers" on page 51).

## To set the default clock rate if the processor clock rate is less than 8 MHz

- Set switch S2 to OPEN.

If a target system's processor clock rate is less than 8 MHz following powerup, the default clock rate must be set to "greater than or equal to 131 kHz" by setting configuration switch 2 OPEN.

This can occur when the target system has the processor running off of an external clock source that is less than 8 MHz or is using the clock synthesizer with a crystal that is lower in frequency than the standard crystal.

The actual processor clock rate should then be communicated to the HP E3490A Software Probe through the configuration processor clock rate entry. The HP E3490A Software Probe will then start communications with the target processor at the 131 kHz processor clock rate. When the configuration process is complete, the HP E3490A Software Probe will change the communication rate to a rate based on the "Processor Clock Rate" parameter entry.

The HP E3490A Software Probe will not communicate correctly with target systems that have a processor clock rate slower than 131 kHz.

---

**Note**

The HP E3490A Software Probe does not automatically match the communication speed to the actual target speed (SYNCR register). Maintaining consistency is the responsibility of the user.

To maintain consistency, specify a correct SYNCR register value in the configuration process and make sure that the target code does not change the SYNCR register to a value that is slower than what is specified in the configuration.

---

---

**Note**

The HP E3490A Software Probe will not run correctly if the actual target processor clock rate is slower than the rate specified in the configuration.

---

## Detailed information about processor clock rates

Most target systems will communicate with the HP E3490A Software Probe properly and with excellent performance following the basic guidelines given in the preceding sections. In some target systems, the setting of this parameter requires greater knowledge of the actual clock generation model.

The CPU32 family has two major use models for the processor clock rate which can be used to support the majority of target systems. When using the internal clock synthesizer, the processor will run from reset at a Motorola defined default clock rate which, when using the Motorola recommended crystal is usually 8.38 MHz or 1/2 of the maximum clock rate of the processor. The programmer's initialization code then programs the clock synthesizer to run at the desired clock rate which is usually higher than the default. The second model uses an external clock source to directly control the processor clock rate. The HP E3490A Software Probe directly supports both processor clock rate models. Users that use a different clock rate model can examine the support of these models to determine the correct settings for supporting their processor clock rate.

The HP E3490A Software Probe supports the use model of the target processor clock rate being increased through the configuration. When applying the configuration at the start of a user interface or through the configuration process, the HP E3490A Software Probe communicates with the target processor at a rate based on the default processor clock rate (either 8 MHz or 131 kHz). At this default rate, it copies the EMSYNCR (EMulator copy of the SYNthesizer Control Register) to the SYNCR (SYNthesizer Control Register). The HP E3490A Software Probe then changes its communications rate to the maximum rate that the processor clock rate specified in the configuration can support.

Resetting the target processor also resets the SYNCR to its default value. If the target processor is reset while running user code (as opposed to putting the processor in a reset state from the interface), no communications rate change takes place within the HP E3490A Software Probe. The initialization code that runs on the target system from reset is required to set the SYNCR to the correct value. If the target processor is reset while in the Background Debug Monitor, the configuration process is executed by the HP E3490A Software Probe.

When the target processor clock rate is fixed through the use of an external clock source, the Processor Clock Rate parameter can be set to the highest

rate that is equal to or less than the target clock rate. There are no dependencies upon any other configuration parameters.

When the target system is using the internal clock synthesizer to increase the final clock rate but the user leaves the HP E3490A Software Probe at the default Processor Type (683xx) the EMSYNCR is not available to the configuration process. The powerup default clock rate for the target system can be entered into the "Processor Clock Rate". This is a failsafe setting but can limit the HP E3490A Software Probe performance if the target processor is programmed to run at a significantly faster rate than the powerup default.

If the user desires the higher performance available by setting the "Processor Clock Rate" configuration parameter to his final value but does not set his processor type (which means that the configuration process cannot set the SYNCR) the debugger interface will have a number of failures when invoked because it cannot communicate accurately with the target processor. These will show up as either question marks or bad values in the code, stack, and monitor windows. These errors can be cleared up if the target system can support a "run from reset" with code in the target system that initializes the target SYNCR register. Following the target initializing this register, a break can be requested and the HP E3490A Software Probe will communicate correctly with the target. Until the HP E3490A Software Probe and the target system are running at compatible rates, operations such as "run" "load" "modify memory/registers" or "display memory/registers" will either fail or give incorrect information.

If the user loses communication between the HP E3490A Software Probe and the target system because of incompatible clock rates, control of the target processor through the HP E3490A Software Probe can be recovered by applying the configuration to the HP E3490A Software Probe with the target processor clock rate set to a known good value.

## Configuring Internal Registers (SIM and EMSIM Registers)

### **Internal Registers**

The CPU32 family of processors provides a variety of internal peripheral and memory modules that are directly connected to the CPU32 core through an internal bus. These modules are configured through memory mapped register banks. The base address of the register banks as well as the base address of internal memory modules are established through Module Configuration Registers (e.g. MCR) and Base Address Registers (e.g. RAMBAR or MBAR). A common module throughout the family is a System Integration Module (SIM) which controls such things as clock speed and external chip selects.

### **How Internal Register Values are Set**

These registers are typically initialized by the CPU32 executing the reset initialization code. During development this code may not be available or may not exist on the target system. To aid in development, the most important of these registers can be set directly by the Software Probe. This enables such functions as clock speed, chip selects, and location of internal memory to be established prior to executing any user code. Once these registers are set, resources in the target system can be accessed in the same manner as the processor would access them after executing the reset initialization code. Activities such as downloading code into the target system can now be performed through the Software Probe.

When the Software Probe is configured with a specific processor type, the configuration process within the user interface presents the internal registers that the Software Probe can initialize. The configuration process stores the user entered values as an emulator copy of these registers. The emulator copy is identified by the prefix

"EM" on the register name (e.g. EMSYNCR is the emulator copy of the SYNCR register) and are referred to as the EMSIM. The EMSIM registers are transferred to the processor registers when the configuration is applied to the emulator, or when the target processor is reset while it is running in the BDM monitor.

Based on the previous discussion, it should be clear that the EMSIM values specified during configuration need to match the intended programming and of use of your CPU32 target system. You need to carefully decide how the processor will be configured and the corresponding SIM values.

### **Methods for Configuring EMSIM Register Values**

There are two methods you can use to configure EMSIM register values:

- Copy values from the SIMs into a configuration file, or
- Manually define each of the EMSIM values using a debugger interface.

---

**Note** The Software Probe supports configuration of the internal registers in the System Integration Module (SIM) and other important Module Configuration Registers and Base Address Registers. To simplify the interface, all configurable registers will be referred to as SIM registers even if they are technically part of another module.

---

---

**Note** Some register values can only be written to once after processor reset. The user interface for the Software Probe performs a reset prior to writing the EM registers to the target processor. If the users code depends upon one of these values to be the default reset value or needs to write something different than what the EM copy contains, the user cannot perform a run directly from the monitor following the application of the configuration. In these cases, the user can only perform a "run from reset" operation. Later break and run cycles within the same debug session will work correctly.

---

## To configure EMSIM values by copying SIM values

If you have initialization code that properly defines the SIMs, you can copy your values of the SIMs into the configuration file. This can be accomplished by the following sequence:

**1 Select Execution→Run from Reset.**

This will run your initialization code.

**2 Enter a <CTRL>-C to abort the run.**

**3 Select Modify→Emulator Config...**

This will bring up the configuration dialog.

**4 Select General Items and enter a processor type, then press OK in the General Items dialog.**

**5 Select Modify→Copy SIM to EMSIM to Config.**

This will copy the actual SIM values into the current configuration.

**6 Click on Apply to Emulator.**

This will load your SIM configuration

**7 Select File→Store... in the configuration dialog box.**

This will allow you to save the configuration in a file. This will also load your SIM configuration.

## To manually define EMSIM values

You can manually define all of the appropriate EMSIM values by the following sequence:

**1 Select **Modify**→**Emulator Config...****

This will open the configuration dialog box.

**2 Select **General Items** and enter a processor type.**

Press **OK** in the General Items dialog.

**3 Select **Reconfigure Internal Registers**.**

**4 Manually enter all of the appropriate values for the registers.**

Use **F1** with the cursor pointed into a register field to get additional information about that particular register.

**5 Click on **Apply to Emulator** to load your SIM configuration.**

Try to access memory as you have defined it.

Make any needed modifications and click on **Apply to Emulator** again until you are satisfied with your configuration.

**6 Select **File**→**Store...****

This allows you to save the configuration in a file. This will also load your SIM configuration.

**See Also**

"Using Internal Registers" beginning on page 71.

---

## To use a configuration file

Once you have saved the configuration, every time that you start the Debugger/Emulator interface you can specify the saved configuration file and have your EMSIMs set up to the proper values. You can do this in two ways:

- Specify the configuration on the command line when you start the debugger interface:

```
db68k -C My_Config -e logical_name
```

- Load the configuration after starting the interface with **File**→**Load**→**Emulator Config...**

## Configuring Simulated IO

The Simulated IO section defines configuration options to allow your programs to use the host computer I/O (display, keyboard, files, etc).

Simulated IO is used as a substitute for the target system IO when it has not been fully developed.

The HP C Cross Compilers provide an environment dependent library (and source code) that uses Simulated IO for its standard IO routines. Simulated IO for MRI compilers is provided in the demo program code. Simulated IO for other brands of compilers can be readily created from the demo code provided. Refer to the demo directory \$HP64000/demo/debug\_env/hpE3490.

### See Also

Refer to the *Simulated I/O User's Guide* for complete details.



5

---

## Configuring the HP E3490A Software Probe Using the Real-Time C Debugger

---

## Configuring the HP E3490A Software Probe Using the Real-Time C Debugger Interface

This chapter tells you how to configure the HP E3490A Software Probe using the HP Real-Time C Debugger interface on a PC.

The HP E3490A Software Probe supports only those features that are common on all the processors in the CPU32 family. Additional processor specific features and capabilities are supported through the use of user configurable parameters and through different interfaces. The parameters may be customized to suit specific target systems and saved in configuration files for future use.

### **What can be configured**

The configurable parameters and their default values are:

- The target processor type.  
Default: determined by which Real-Time C Debugger you are using.
- The target processor clock rate (determines BDM communication speed).  
Default:  $\geq 8$  MHz if configuration switch #2 is CLOSED.  
Default:  $\geq 131$  kHz if configuration switch #2 is OPEN.
- Initial values for memory mapped registers in internal modules  
Default: Memory-mapped registers are not defined

---

## To configure the HP E3490A Software Probe

**1** Set the processor type, processor clock rate, and EMSIM register values as described in this chapter.

**2** Select **Execution**→**Reset**.

This will reset the target system.

**3** Select **Execution**→**Break**.

When the break occurs the following "configuration process" occurs:

- The target processor enters the BDM monitor.
- The BDM communication speed is set to the default clock rate.
- The emulation copies of the SIM registers (set in step 1) are loaded into the target SIM.
- The BDM communication speed is set to the rate based on the value configured as the target processor clock rate.

## To set the processor type

- 1** In the Hardware Configuration dialog box, select the processor type.
- 2** Click on the **OK** button.

If you are using a processor in your target that is not listed as a choice in the dialog box, the HP E3490A Software Probe can provide direct access to all the registers defined in the CPU32 architecture programming model but will not have direct access to memory mapped registers in the processor's internal modules.

If you are using a processor that is listed as a choice in the dialog box, the HP E3490A Software Probe will have knowledge of on-chip peripheral registers and SIM registers and will allow display and modification from the user interface. For example, when 68332 is selected as the processor type, the interface will support direct access to the SIM, the QSM, the TPU, and the TPURAM registers.

The supported processor types are listed in the configuration dialog box.

The HP E3490A Software Probe does not have explicit support for all CPU32 processors. When using a member of the CPU32 family that is not explicitly supported it may be possible to select a processor that is a formal subset of the unsupported processor. This will provide direct access to all of the internal memory mapped registers that are common. Since the registers in the internal modules are memory mapped, registers in unsupported CPU32 processors are also accessible through the memory commands. For example, on a 68332, SIM registers can be accessed at memory locations 7FFA00 to 7FFA7F or FFFA00 to FFFA7F.

---

## Setting the Processor Clock Rate (BDM Communication Speed)

The HP E3490A Software Probe needs to be configured to communicate at a rate which is compatible with your target processor clock rate. This can be done through your user interface software.

If your target processor runs at less than 8 MHz after power-up, you will also need to set a configuration switch on the HP E3490A Software Probe.

## To set the processor clock rate (BDM communication speed)

- 1** Select **Settings**→**Emulator Config**→**Hardware...**
- 2** Select a Processor Clock Rate.
- 3** Click on the **OK** button.

The processor clock rate configuration parameter is used to specify the maximum rate that the HP E3490A Software Probe can communicate with the target processor through the BDM port. This maximum communication rate is based upon the target processor type and the target processor clock rate. The maximum communication rate directly impacts the performance of downloading files through the HP E3490A Software Probe and the intrusion time when polling. Running at a rate slower than the maximum does not prevent correct operation.

The default value for the processor clock rate configuration parameter is determined by the setting of configuration switch S2. In the Normal (CLOSED) position this parameter is set to "greater than or equal to 8 MHz". In the OPEN position this parameter is set to "greater than or equal to 131 kHz".

Most target systems run with a Processor Clock Rate of 8 MHz or above and so will function properly using the default value. For correct operation in target systems that run slower than 8 MHz, the default clock rate must be set to "greater than or equal to 131 kHz" by setting switch S2 to OPEN.

The best performance for the HP E3490A Software Probe usually requires changing the communication rate from the default value. Set the "Processor Clock Rate" parameter to the highest rate that is equal to or less than the target running clock rate. If using the internal clock synthesizer, set the EMSYNCR (EMulator copy of the SYNthesizer Control Register, SYNCR) to the same value as set by the initialization code. (See "Configuring Internal Registers" on page 51).

## To set the default clock rate if the processor clock rate is less than 8 MHz

- Set switch S2 to OPEN.

If a target system's processor clock rate is less than 8 MHz following powerup, the default clock rate must be set to "greater than or equal to 131 kHz" by setting configuration switch 2 OPEN.

This can occur when the target system has the processor running off of an external clock source that is less than 8 MHz or is using the clock synthesizer with a crystal that is lower in frequency than the standard crystal.

The actual processor clock rate should then be communicated to the HP E3490A Software Probe through the configuration processor clock rate entry. The HP E3490A Software Probe will then start communications with the target processor at the 131 kHz processor clock rate. When the configuration process is complete, the HP E3490A Software Probe will change the communication rate to a rate based on the "Processor Clock Rate" parameter entry.

The HP E3490A Software Probe will not communicate correctly with target systems that have a processor clock rate slower than 131 kHz.

---

**Note**

The HP E3490A Software Probe does not automatically match the communication speed to the actual target speed (SYNCR register). Maintaining consistency is the responsibility of the user.

To maintain consistency, specify a correct SYNCR register value in the configuration process and make sure that the target code does not change the SYNCR register to a value that is slower than what is specified in the configuration.

---

---

**Note**

The HP E3490A Software Probe will not run correctly if the actual target processor clock rate is slower than the rate specified in the configuration.

---

## Detailed information about processor clock rates

Most target systems will communicate with the HP E3490A Software Probe properly and with excellent performance following the basic guidelines given in the preceding sections. In some target systems, the setting of this parameter requires greater knowledge of the actual clock generation model.

The CPU32 family has two major use models for the processor clock rate which can be used to support the majority of target systems. When using the internal clock synthesizer, the processor will run from reset at a Motorola defined default clock rate which, when using the Motorola recommended crystal is usually 8.38 MHz or 1/2 of the maximum clock rate of the processor. The programmer's initialization code then programs the clock synthesizer to run at the desired clock rate which is usually higher than the default. The second model uses an external clock source to directly control the processor clock rate. The HP E3490A Software Probe directly supports both processor clock rate models. Users that use a different clock rate model can examine the support of these models to determine the correct settings for supporting their processor clock rate.

The HP E3490A Software Probe supports the use model of the target processor clock rate being increased through the configuration. When applying the configuration at the start of a user interface or through the configuration process, the HP E3490A Software Probe communicates with the target processor at a rate based on the default processor clock rate (either 8 MHz or 131 kHz). At this default rate, it copies the EMSYNCR (EMulator copy of the SYNthesizer Control Register) to the SYNCR (SYNthesizer Control Register). The HP E3490A Software Probe then changes its communications rate to the maximum rate that the processor clock rate specified in the configuration can support.

Resetting the target processor also resets the SYNCR to its default value. If the target processor is reset while running user code (as opposed to putting the processor in a reset state from the interface), no communications rate change takes place within the HP E3490A Software Probe. The initialization code that runs on the target system from reset is required to set the SYNCR to the correct value.

When the target processor clock rate is fixed through the use of an external clock source, the Processor Clock Rate parameter can be set to the highest rate that is equal to or less than the target clock rate. There are no dependencies upon any other configuration parameters.

For the 6833x interface, when the target system is using the internal clock synthesizer to increase the final clock rate but the user leaves the HP E3490A Software Probe at the default processor type (683xx) the EMSYNCR is not available to the configuration process. The powerup default clock rate for the target system can be entered into the "Processor Clock Rate". This is a failsafe setting but can limit the HP E3490A Software Probe performance if the target processor is programmed to run at a significantly faster rate than the powerup default.

If the user desires the higher performance available by setting the "Processor Clock Rate" configuration parameter to his final value but does not set his processor type (which means that the configuration process cannot set the SYNCR) the debugger interface will have a number of failures when invoked because it cannot communicate accurately with the target processor. These will show up as either dashes or bad values in the source, backtrace, and memory windows. These errors can be cleared up if the target system can support a "run from reset" with code in the target system that initializes the target SYNCR register. Following the target initializing this register, a break can be requested and the HP E3490A Software Probe will communicate correctly with the target. Until the HP E3490A Software Probe and the target system are running at compatible rates, operations such as "run," "load," "modify memory/registers," or "display memory/registers" will either fail or give incorrect information.

If the user loses communication between the HP E3490A Software Probe and the target system because of incompatible clock rates, control of the target processor through the HP E3490A Software Probe can be recovered by applying the configuration to the HP E3490A Software Probe with the target processor clock rate set to a known good value.

## Configuring Internal Registers (SIM and EMSIM Registers)

### **Internal Registers**

The CPU32 family of processors provides a variety of internal peripheral and memory modules that are directly connected to the CPU32 core through an internal bus. These modules are configured through memory mapped register banks. The base address of the register banks as well as the base address of internal memory modules are established through Module Configuration Registers (e.g. MCR) and Base Address Registers (e.g. RAMBAR or MBAR). A common module throughout the family is a System Integration Module (SIM) which controls such things as clock speed and external chip selects.

### **How Internal Register Values are Set**

These registers are typically initialized by the CPU32 executing the reset initialization code. During development this code may not be available or may not exist on the target system. To aid in development, the most important of these registers can be set directly by the HP E3490A Software Probe. This enables such functions as clock speed, chip selects, and location of internal memory to be established prior to executing any user code. Once these registers are set, resources in the target system can be accessed in the same manner as the processor would access them after executing the reset initialization code. Activities such as downloading code into the target system can now be performed through the HP E3490A Software Probe.

The emulator copy is identified by the prefix "EM" on the register name (e.g. EMSYNCR is the emulator copy of the SYNCR register) and are referred to as the EMSIM. The EMSIM registers are

transferred to the processor registers when the target processor is reset while it is running in the BDM monitor.

The names and values of the EMSIM registers are displayed in the Emulator SIM Registers window.

Based on the previous discussion, it should be clear that the EMSIM values specified during configuration need to match the intended programming and of use of your CPU32 target system. You need to carefully decide how the processor will be configured and the corresponding SIM values.

### **Methods for Configuring EMSIM Register Values**

There are two methods you can use to configure EMSIM register values:

- Copy values from the SIMs into the EMSIM registers, or
- Manually define each of the EMSIM values using a debugger interface.

---

**Note**

The HP E3490A Software Probe supports configuration of the internal registers in the System Integration Module (SIM) and other important Module Configuration Registers and Base Address Registers. To simplify the interface, all configurable registers will be referred to as SIM registers even if they are technically part of another module.

---

## To copy EMSIM values to the SIM registers

You can copy values from the EMSIM registers into the SIM registers in two ways:

- Using the Configuration Information dialog.
  - a Select **Settings**→**Emulator Config**→**Information**.
  - b Select **Synchronize from emsim regs, copy to processor regs** in the Synchronize SIM Registers box.
  - c Click on **Apply/Results**.
- Resetting the target system.
  - a Select **Execution**→**Reset**.
  - b Select **Execution**→**Break**.

---

### Note

Some registers can only be written once after processor reset.

If you set the EMSIM values, then reset and break, the EMSIM values will be written to the SIM registers. If your initialization code then attempts to write to one of the "write once after reset" registers, the writes will fail. In this case, you must use the **Execution**→**Run...From Reset** command to correctly execute the initialization code.

---

## To configure EMSIM values by copying SIM values

If you have initialization code that properly defines the SIMs, you can copy your values of the SIMs into the configuration file. This can be accomplished by the following sequence:

- 1 Select **Execution**→**Run...**
- 2 Select **User Reset** and then **Run**.  
This will run your initialization code.
- 3 Select **Execution**→**Break** to stop the execution.
- 4 Select **Settings**→**Emulator Config**→**Information**.  
This will bring up the Configuration Information dialog.
- 5 Select **Synchronize from processor sim regs, copy to emsim regs** in the Synchronize SIM Registers box.
- 6 Click on **Apply/Results**.

This will copy your SIM configuration into the EMSIM registers.

---

**7 Select File→Save Emulator Config** from the menu bar.

This will allow you to save the configuration in a file.

---

### To manually define EMSIM values

- 1** Open the SIM/MEMC Registers window.
- 2** Double-click on the VALUE field for the register you want to define.

This will open the Register Bit Fields window.

This will not change the value of the SIM register. To apply the new value to the corresponding SIM register, see "To copy EMSIM values to the SIM registers."

---

### To load EMSIM values from a configuration file

Once you have saved the configuration, you can specify the saved configuration file and have your EMSIMs set up to the proper values.

- **Select File→Load Configuration.**

This will not change the SIM registers. To apply the new values to the corresponding SIM registers, see "To copy EMSIM values to the SIM registers."



6

---

## Using Internal Registers (EMSIM Registers)

---

## Using Internal Registers (EMSIM registers)

### **The purpose of EMSIM registers**

Software Probe maintains a set of pseudo registers known as EMSIM registers. There is a one to one correspondence between the the EMSIM registers and the target SIM registers. The purpose of the EMSIM registers is to provide a stable, known set of registers that can be copied into the SIM to establish an initial SIM state or re-establish a previous known state. This is useful because it allows Software Probe to communicate with a target without first running initialization code to set up the chip select registers.

---

**Note**

The Software Probe supports configuration of the internal registers in the System Integration Module (SIM) and other important Module Configuration Registers and Base Address Registers. To simplify the interface, all configurable registers will be referred to as SIM registers even if they are technically part of another module.

---

## Using EMSIM Registers with the Debugger/Emulator Interface

### **The effect of processor type on the EMSIM registers**

EMSIM registers only exist if the HP E3490A Software Probe has been configured with a target processor name other than 683xx. If the processor is 683xx, the HP E3490A Software Probe does not know what type of SIM exist in the target and will have no knowledge of SIM registers.

---

### **To copy EMSIM registers to target SIM registers**

EMSIM registers can be copied to the target SIM in several ways.

- In a Debugger Emulator interface, EMSIMs are copied to target SIMs each time a configuration is applied to Software Probe. This happens automatically when a user interface is started. Configurations may also be applied manually from within the user interface by choosing **Modify→Emulator Config...** and then **Apply to Emulator**
  - In a Debugger/Emulator interface choose **Modify→SIM registers→Copy emulator SIM to processor SIM**.  
In addition, EMSIMs are copied to target SIMs when the target processor is reset while it is running in the BDM monitor
- 

### **To copy target SIM registers to EMSIM registers**

Target SIM registers may be copied to the EMSIM in several ways.

---

- In a Debugger Emulator interface choose **Modify→Emulator Config...** Then issue the command **Modify→Copy SIM to EMSIM to Config**
- In a Debugger Emulator interface choose **Modify→SIM registers→Copy SIM to Emulator SIM**

---

### To compare SIM and EMSIM registers

Target SIM registers may compared to the the EMSIM to determine if they have changed.

- In a Debugger Emulator interface choose **Display→SIM Register Differences.**

When displaying differences between SIMs and EMSIMs, register names will not be show. Registers will be identified by a memory offset from their base address in the target system.

## Using EMSIM Registers with the Real-Time C Debugger Interface

### **The effect of processor type on the EMSIM registers**

If you are using the 6833x Real-Time C Debugger interface, EMSIM registers are valid only if the HP E3490A Software Probe has been configured with a target processor name other than 683xx. If the processor is 683xx, the HP E3490A Software Probe does not know what type of SIM exist in the target and will not display correct values for the SIM registers.

---

### **To copy EMSIM registers to target SIM registers**

You can copy values from the EMSIM registers into the SIM registers in two ways:

- Using the Configuration Information dialog.
  - a Select **Settings**→**Emulator Config**→**Information**.
  - b Select **Synchronize from emsim regs, copy to processor regs** in the Synchronize SIM Registers box.
  - c Click on **Apply/Results**.
- Resetting the target system.
  - a Select **Execution**→**Reset**.
  - b Select **Execution**→**Break**.

---

**Note**

Some registers can only be written once after processor reset.

If you set the EMSIM values, then reset and break, the EMSIM values will be written to the SIM registers. If your initialization code then attempts to write to one of the "write once after reset" registers, the writes will fail. In this case, you must use the **Execution**→**Run...From Reset** command to correctly execute the initialization code.

---

## To copy target SIM registers to EMSIM registers

If you have initialization code that properly defines the SIMs, you can copy your values of the SIMs into the configuration file. This can be accomplished by the following sequence:

- 1 Select **Settings**→**Emulator Config**→**Information**.  
This will bring up the Configuration Information dialog.
- 2 Select **Synchronize from processor sim regs, copy to emsim regs** in the Synchronize SIM Registers box.
- 3 Click on **Apply/Results**.  
This will copy your SIM configuration into the EMSIM registers.

---

## To compare SIM and EMSIM registers

Target SIM registers may be compared to the EMSIM to determine if they have changed.

- 1 Select **Settings**→**Emulator Config**→**Information**.  
This will bring up the Configuration Information dialog.
- 2 Select **Show differences for processor and emsim regs** in the Synchronize SIM Registers box.
- 3 Click on **Apply/Results**.  
This will display the differences between the SIM and EMSIM register sets.

---

### Note

The HP E3490A Software Probe, when comparing SIM and EMSIM registers, will not compare EMSIM registers that have not been set.

When you first turn on the HP E3490A Software Probe and the target system and start the Real-Time C Debugger, the **Show differences for processor and emsim regs** command will not find any differences. If one register is modified, just that one register may show differences. A complete check of the register differences will occur only if a complete configuration is loaded or the SIM registers are copied to the EMSIM registers. Once written, any EMSIM register will be considered valid until you cycle power on the HP E3490A Software Probe.

---

## Internal Representation of SIM and EMSIM Registers

Internal to the HP E3490A Software Probe the EMSIM and SIM memory spaces are accessed using memory suffixes of the form `offset@emsim` and `offset@reg`. All memory mapped registers in the 683xx family are contained within a contiguous 4k block of memory (8k for the 68360). The base address is determined by the SIM MCR MM bit in the 6833x or the MBAR in the 68340 and 68360 processors. The internal representation within the HP E3490A Software Probe of these registers is maintained as an offset to the memory mapped register base. Referencing memory as `offset@emsim` will access a SIM copy value in the EMSIM. Referencing `offset@reg` will access a register within the processor. For example the memory address `0a00@reg` within a 68332 will access the SIM MCR. The memory address `0@reg` within a 68340 will access its SIM MCR.

Typically these internal representations of `offset@emsim` and `offset@reg` will not be seen by the user of the HP E3490A Software Probe via the workstation debugger or the the PC RTC interfaces. Currently though, a command used to compare the values with the EMSIM and SIM will result in memory references using this notation. For example suppose the command is given to compare the SIM and EMSIM within the 68332. Further suppose that the the values in the Clock Synthesizer Control differ. This is the SIM register SYNCR. The resulting display may look as follows:

```
0a04@emsim=000, 0a04@reg=03f
0a05@emsim=000, 0a05@reg=008
```

At this point the user must refer to the 68332 data book to understand which SIM register is differing. In future versions of the HP E3490A Software Probe interface the register names will be displayed, completely hiding the use of the `offset@` syntax.

**See Also**

Page 51 in the "Configuring the HP E3490A Software Probe" chapter for additional information on EMSIM registers.

---

7

---

# Programming Target Flash Memory

## Programming Target Flash Memory

You can use the HP E3490A Software Probe to program flash memory on your target system.

### **Target system configuration**

Prior to erasing or programming parts through the HP E3490A Software Probe, you must establish any necessary options on the target system. This can include enabling the programming voltage ( $V_{PP}$ ), disabling write protection, or properly setting the chip selects in the SIM. The chip selects in the SIM can be set through the configuration process. The documentation on the target system can provide information on such things as establishing the  $V_{PP}$  and disabling any target based write protection. The HP E3490A Software Probe accomplishes the FLASH ROM erasure and programming through standard target bus writes and reads.

### **Supported Parts**

The HP E3490A Software Probe can program standard Intel and AMD parts, and equivalent parts from other manufacturers. Supported algorithms include the Intel quick-pulse (or the identical AMD Flashrite), Intel Auto, AMD 5V embedded, and AMD 12V embedded algorithms.

Since the list of supported parts may change frequently, refer to the on-line help in your user interface software.

### **Supported File Sizes**

There is no file size limit.

### **Supported User Interfaces**

The following user interfaces support flash programming:

- On an HP or Sun workstation, you can use the HP Debugger/Emulator.
- On a PC, you can use the HP Real-Time C Debugger.

## To program or erase a part using the HP Debugger/Emulator

- 1 Create a file which contains the data to be flashed.
- 2 Set the necessary options (if any) on your target system to allow flash programming.
- 3 Open the FLASH Operations dialog box by selecting **Modify**→**FLASH Erase...** or **File**→**Load**→**FLASH From File** from the menu bar.

- 4 Program the part by clicking on **OK** or **Apply** in the dialog box.

The dialog box supports erasure of parts and programming from different binary files. You must select the programming algorithm to use, the base address and size of the FLASH ROM, and the configuration of the FLASH ROM. Sector erasable parts can be erased a sector at a time if desired.

Currently supported parts and algorithms can be identified through the F1 help function in the dialog box.

---

## To program or erase a part using the HP Real-Time C debugger

- 1 Create a file which contains the data to be flashed.
- 2 Set the necessary options (if any) on your target system to allow flash programming.
- 3 Open the FLASH dialog box by selecting **File**→**Flash Programming...** from the menu bar.
- 4 Select the appropriate options to program your flash memory.
- 5 Program the part by clicking on **OK** or **Apply** in the dialog box.

---

## Part 3

---

## Reference



---

8

---

## Designing a Target System

---

## Designing a Target System

This chapter will help you design a target system that will work with the HP E3490A Software Probe.

---

### Wiring the BDM Port

Some of the signals at the BDM port share the same lines, as shown in the diagrams on the following pages.

When deciding whether to use an 8-pin or a 10-pin BDM port, consider how often you are likely to encounter "hung" bus cycles. If you are using an 8-pin BDM port, and a target bus cycle fails to terminate, you will need to reset the target system. If you use a 10-pin BDM port, the HP E3490A Software Probe will detect and terminate the "hung" cycle.

Therefore if your target system does not have a good bus monitor, or if you are not using the built-in bus monitor, you should use a 10-pin BDM port to take advantage of the  $\overline{DS}$  and  $\overline{BERR}$  signals.

The following signals should be available at the BDM port:

---

**BDM signal definitions**

---

Mnemonic	Name	Direction	Signal Description
GND	Ground		
$\overline{\text{BKPT}}$	Breakpoint	Input (to target)	Signals a hardware breakpoint. Also used to place the CPU32 in background debug mode. Active low
DSCLK	Development system clock	Input	Serial input clock
FREEZE	Freeze	Output	Indicates BDM mode
QUOT	Quotient out	Output	Quotient bit of the polynomial divider. Not used in BDM mode.
$\overline{\text{RESET}}$	Reset	Output	Indicates system reset
$\overline{\text{IFETCH}}$	Instruction fetch	Output	Indicates when the CPU is performing an instruction word prefetch and when the instruction pipeline has been flushed (active low)
DSI	Development serial in	Input	BDM data input
$V_{DD}$		Output	Target power (+5 V or +3.3 V)
$\overline{\text{IPIPE}}$	Instruction pipe	Output	Used to track the movement of words through the instruction pipeline (active low)
DSO	Development serial out	Output	BDM data output
$\overline{\text{DS}}$	Data strobe	Output	During read, indicates ready to receive valid data; during write, indicates that valid data is on the bus; used by the HP E3490A Software Probe to indicate that a bus cycle is in progress (optional)
$\overline{\text{BERR}}$	Bus error	Input	Used to terminate target memory cycles (optional)

---

### 8-pin BDM port

If you plan to use the provided 8-pin cable, the BDM port should be a dual row header strip ("Berg connector"), 4 pins per row, 10 pins per inch, with 25 mil pins. If you plan to use the 10-pin cable, use a header with 2 rows of 5 pins.

If you plan to use the provided 8-pin cable, you should use the following pin assignments for the BDM port:



E3490806

### 10-pin BDM port

If you plan to use the provided 10-pin cable, you should use the following pin assignments for the BDM port:



E3490807

### Target $V_{\text{DD}}$

The HP E3490A Software Probe may draw up to 10 mA from target  $V_{\text{DD}}$ .

Read the specifications on page 92 for more information on current and voltage requirements.

### CONFIG2 pin

The CONFIG2 pin on CPU32+ processors shares a pin with the processor FREEZE output. The HP E3490A Software Probe can pull

this line down and cause the CPU32+ to power up in Slave Mode with the internal CPU disabled. To ensure that CONFIG2 is high at reset, the target should supply sufficient pullup current to drive the FREEZE input on the HP E3490A Software Probe. Loading for the FREEZE pin (and all BDM pins) is described in the "Specifications" chapter.

---

## Enabling BDM

Your target system does not need to enable background debug mode.

If the HP E3490A Software Probe is connected and turned on before you turn on the target system, the HP E3490A Software Probe will enable BDM.

If you connect the HP E3490A Software Probe after you turn on the target system, the HP E3490A Software Probe will enable BDM when the target is reset.

If you turn on the HP E3490A Software Probe while it is connected to a running target system, the HP E3490A Software Probe will reset the target system.



---

9

---

## Specifications and Characteristics

## Processor Compatibility

The HP E3490A Software Probe supports the Motorola MC68331, MC68332, MC68333, MC68334, MC68335, MC68336, MC68340, and MC68360 microprocessors operating at clock speeds up to 25 MHz. (Other processors and clock speeds may be supported. Contact HP for a complete list.)

The HP E3490A Software Probe supports both 5V and 3.3V operation.

---

## Electrical Specifications

### **BNC, labeled TRIGGER OUT**

**Output Drive** Logic high level with 50-ohm load  $\geq 2.0$  V when in BDM monitor. Logic low level with 50-ohm load  $\leq 0.4$  V when running user code or when in reset.

### **BNC, labeled BREAK IN**

**Input** Edge-triggered TTL level input (active high), 20 pf, with 2K ohms to ground in parallel. Maximum input: 5 V above  $V_{CC}$ ; 5 V below ground. When this input is driven, the target system is forced into background mode.

### **Communications**

**Serial Port** 9-pin female type "D" subminiature connector. RS-232 DCE to 115.2 kbaud.

**10BASE-T LAN Port** RJ-45 connector. IEEE 802.3 10BASE-T (StarLAN).

**10BASE 2 LAN Port** 50-ohm BNC connector. IEEE 802.3 10BASE2 (ThinLAN). When using this connector, the HP E3490A Software Probe provides the functional equivalent of a Medium Attachment Unit (MAU) for ThinLAN.

### **Power Supply**

**Input** 100-240 V, 9.75 A, 50/60 Hz, IEC 320 connector.

**Output** 5 V, 1.0 A

**Accessory Output** 100-240 V, 9.50 A, 50/60 Hz

---

## Maximum Ratings

Characteristic	Symbol	Value	Unit
Supply Voltage from Target	V <sub>DD</sub>	-0.3 to +5.5	V

Characteristic	Symbol	V <sub>DD</sub> = 5 Volts		V <sub>DD</sub> = 3.3 Volts		Unit
		Min	Max	Min	Max	
Input Current (V <sub>DD</sub> )	I <sub>II</sub>		10		6	mA
Input Voltage	V <sub>in</sub>	V <sub>SS</sub> -0.5	V <sub>DD</sub> +0.5	V <sub>SS</sub> -0.5	V <sub>DD</sub> +0.5	V
Input High Voltage	V <sub>Ih</sub>	2	V <sub>DD</sub> +0.5	2	V <sub>DD</sub> +0.5	V
Input Low Voltage	V <sub>Il</sub>	V <sub>SS</sub> -0.5	0.8	V <sub>SS</sub> -0.5	0.8	V
Input High Current	I <sub>Ih</sub>		-20		-15	μA
Input Low Current	I <sub>Il</sub>		0.6		0.35	mA
Input Capacitance	C <sub>in</sub>		40		40	pF
Output High Voltage (BKPT_L, IFETCH_L/DSI)	V <sub>oh</sub>	3.86		3		V
Output High Current (BKPT_L, IFETCH_L/DSI)	I <sub>oh</sub>	-4		-2		mA
Output Low Voltage (BKPT_L, IFETCH_L/DSI)	V <sub>ol</sub>	0.4		0.4		V
Output Low Current (BKPT_L, IFETCH_L/DSI)	I <sub>ol</sub>	3.4		3.4		mA
Output Low Voltage (BERR_L, RESET_L), I <sub>ol</sub> = 12 mA*	V <sub>ol</sub>	0.4		0.4		V
Output Low Voltage (BERR_L, RESET_L), I <sub>ol</sub> = 24 mA*	V <sub>ol</sub>	0.5		0.5		V

\*The V<sub>oh</sub> specification for BERR\_L and RESET\_L is not applicable because they are OPEN-collector outputs.

Input-only pins: V<sub>DD</sub>, DS\_L, FREEZE, I\_PIPE\_L/DSO

Output-only pins: BKPT\_L

Input/output pins: IFETCH\_L/DSI, BERR\_L, RESET\_L

## **Environmental Specifications**

### **Temperature**

Operating, 0 to +40 °C (+32 to +104 °F); nonoperating, -40 to +60 °C (-40 to +140 °F).

### **Altitude**

Operating/nonoperating 4600 m (15 000 ft).

### **Relative Humidity**

15% to 95%.

---

10

---

Updating Firmware

## Updating Firmware

Hewlett-Packard formally supports only configurations that include the latest revisions of all software and firmware. Software updates can be ordered to get the latest firmware revisions.

You can update the firmware in the HP E3490A Software Probe by running the progflash utility program. Progflash downloads code from files on the host computer into Flash EPROM memory which is built-in to the HP E3490A Software Probe.

This chapter describes how to:

- Order the software updates.
- Update firmware with the "progflash" command.
- Display current firmware version information.

---

## To order the software updates

- 1 Order the HP BasicLine software support service for the products that are to be kept up to date. The Software Update Materials will include files for updating firmware as well as the host-resident user interface software.
- 2 Order Software Materials Subscription (SMS) subscriptions for the products that contain the **progflash** program and the flashware.

If you're using the HP E3490A Software Probe with an HP 9000 computer or a Sun SPARCsystem computer:

The HP B1471 64700 Operating Environment product contains the progflash program.

The graphical Debugger/Emulator interface product contains flashware.

If you're using an IBM PC AT compatible computer:

The HP 64700BX Option 006 product contains the progflash program.

The Real-Time C Debugger product contains flashware for the HP E3490A Software Probe.

---

## To update firmware with "progflash"

- 1 Make sure your HP E3490A Software Probe is listed in the 64700tab.net file.
- 2 Install the update software on your computer.

The following table describes the files that are used when updating firmware.

---

### Files Used During Firmware Updates

---

File	Description	Location on HP 9000 or Sun SPARCsystem computers	Location on IBM PC AT compatible computers
progflash	Executable program.	\$HP64000/bin	\hp64700\bin
<product>.cfg	Product configuration file.	\$HP64000/inst/update	\hp64700\update
<product>.X	Product code file.		

- 3 Enter the **progflash** command.
- 4 Answer the questions asked by the **progflash** command.

The progflash command downloads code from files on the host computer into Flash EPROM memory in the HP E3490A Software Probe.

Instead of running progflash interactively, you may use options to the progflash command:

**progflash [-v] [emul\_name] [products\_to\_update ...]**

The -v option means "verbose". It causes progress status messages to be displayed during operation.

The emulname option is the logical emulator name as specified in the 64700tab or 64700tab.net file.

The products\_to\_update option names the products whose firmware is to be updated. For the HP E3490A Software Probe, the product name is "E3490".

If you enter the progflash command without options, it becomes interactive. If you don't include the "emulname" option, it displays the logical names in the 64700tab or 64700tab.net file and asks you to choose one. If you don't include the "products\_to\_update" option, it displays the products which have firmware update files on the system and asks you to choose one. (In the interactive mode, only one product at a time can be updated.) You can abort the interactive progflash command by pressing <CTRL>c.

Progflash will print "Flash programming SUCCEEDED" and return 0 if it is successful; otherwise, it will print "Flash programming FAILED" and return a nonzero (error).

You can verify the update by displaying the firmware version information.

---

**Example**

To use update the firmware in "myprobe", you could enter the following command:

```
progflash -v myprobe E3490
```

---

## To display current firmware version information

- Use **telnet** or a terminal emulator to access the built-in "terminal interface" and use the **ver** command to view the version information for firmware currently in the HP E3490A Software Probe.

---

## If the firmware doesn't appear to be updated

Though Flash EPROM is very reliable, it can fail. If the HP E3490A Software Probe determines the Flash EPROM is not working, it will try to use the boot code in its Flash EPROMs. The only useful operation the boot code allows is running progflash.

- Make sure the current version information is incorrect by comparing it with the version numbers of the update software.
- Try updating the firmware again.

If none of these steps solves the problem, contact your local HP Representative.

---

## If there is a power failure during a firmware update

If there is a power glitch during a firmware update, some bits may be lost during the download process, possibly resulting in an HP E3490A Software Probe that will not boot up.

- Set switch S4 to OPEN, then cycle power. This tells the HP E3490A Software Probe to ignore everything in the Flash EPROM except the boot code.
- Repeat the firmware update process.
- Set switch S4 to CLOSED, then cycle power. This restores the HP E3490A Software Probe to its normal mode.

### See Also

"If the data in ROM is corrupt" on page 120.

---

11

---

Solving Problems

## Solving Problems

If you have problems with the HP E3490A Software Probe, your first task is to determine the source of the problem. Problems may originate in any of the following places:

- The HP E3490A Software Probe itself
- The connection between the HP E3490A Software Probe and your host computer
- The software on the host computer
- The connection between the HP E3490A Software Probe and the target system
- The target system

You can use several means to determine the source of the problem:

- The status lights on the HP E3490A Software Probe
- Error messages displayed on the host computer
- Diagnostic tests performed using the host computer
- The HP E3490A Software Probe "performance verification" tests

### Status lights

The following illustration shows the status lights on both sides of the HP E3490A Software Probe and what they mean:

Lit when the target processor is running in normal (user program) mode

Lit when the target processor is running in background debug mode

Lit when the target system is in a reset state

Lit when the power supply is properly connected

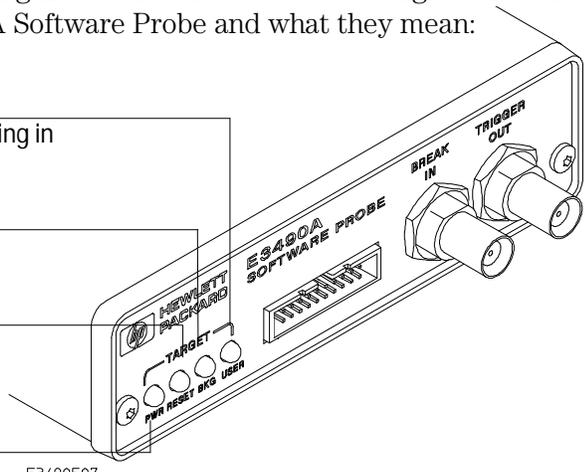

Lit when LAN data is being transmitted

Lit when 10BASE-T connection has a good link; not used for 10BASE2

Lit when the polarity on the receive twisted pair is reversed for a 10BASE-T connection

Lit when LAN data is being received

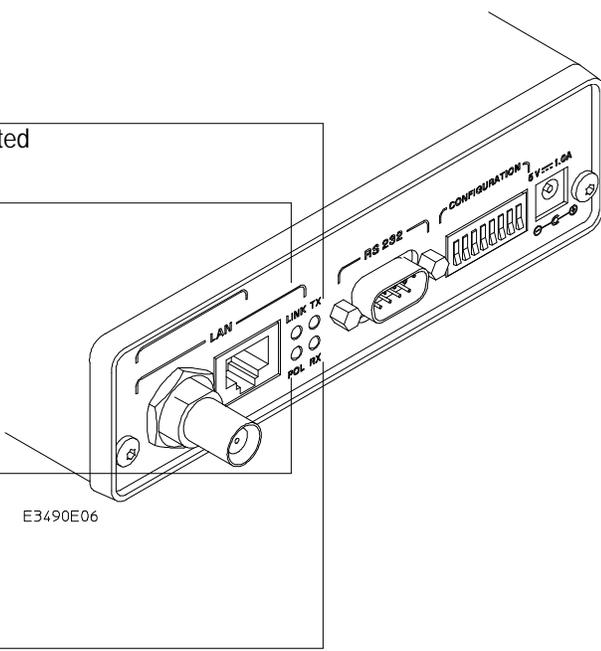

---

## Status Lights

The HP E3490A Software Probe communicates various modes and error conditions via the status lights. The meanings of the status lights are shown on the previous page.

The following table gives more information about the meaning of the power and target status lights.

○ = LED is off

● = LED is on

\* = Not applicable (LED is off or on)

---

### Power/Target Status Lights

---

Pwr/Target LEDs	Meaning
○○○○	HP E3490A Software Probe is not connected to power supply
●○○○	No target system power, or HP E3490A Software Probe is not connected to the target system
●●○○	Target system is in a reset state
●○●●	Only boot firmware is good (other firmware has been corrupted)
●○●○	Target system is executing in Background Debug Mode
●○○●	Target system is executing user code

---

## Problems with the LAN Interface

---

---

### If you cannot verify LAN communication

Use the "telnet" command on the host computer to verify LAN communication. After powering up the HP E3490A Software Probe, it takes up to a minute before the HP E3490A Software Probe can be recognized on the network. After a minute, try the "telnet <internet address>" command.

If "telnet" does not make the connection:

- Make sure that you have connected the HP E3490A Software Probe to the proper power source and that the power light is lit.
- Make sure that the LAN cable is connected. Refer to your LAN documentation for testing connectivity.
- Make sure that only one of the LAN ports is connected.
- Make sure the HP E3490A Software Probe communication configuration switches are set correctly. Unplug the HP E3490A Software Probe power cord, then plug it in again to make sure the switch settings are read correctly by the HP E3490A Software Probe.
- Make sure that the HP E3490A Software Probe's IP address is set up correctly. Use the RS-232 port to verify this that the IP address is set up correctly. When you are connected to the RS-232 port, run performance verification on the HP E3490A Software Probe's LAN interface with the "pv" command.

If "telnet" makes the connection, but no prompt (for example, R>, M>, U>, etc.) is supplied:

- It's possible that the host software is in the process of running a command. You can use <CTRL>c to interrupt and get the Terminal Interface prompt.
- It's also possible for there to be a problem with the HP E3490A Software Probe firmware while the LAN interface is still up and running. In this case, you must reboot the HP E3490A Software Probe by disconnecting power to the HP E3490A Software Probe and reconnecting it again.

---

## If you have LAN connection problems

- Try to "ping" the HP E3490A Software Probe. At your operating system prompt, type:

```
ping <hostname or IP address>
```

If it does not respond:

1. Check that switch S1 is "0" (attached to LAN, not RS-232).
2. Check that switch S5 is in the correct position for your LAN interface (either 10BASE2 or 10BASE-T).

(Remember: if you change any switch settings, the changes do not take effect until you cycle power.)

- If the HP E3490A Software Probe still does not respond to a "ping", you need to verify the IP address and gateway mask of the HP E3490A Software Probe. To do this, connect the HP E3490A Software Probe to a terminal or terminal emulator (see page 20), change the switch settings so it is connected to RS-232, and enter the "lan" command. The output looks something like this:

```
lan -i 15.5.24.116
lan -g 15.5.23.1
lan -p 6470
Ethernet Address : 08000909BAC1
```

"lan -i" shows the internet address is 15.5.24.116 in this case. If the Internet address (IP) is not what you expect, you can change it with the 'lan -i <new IP>' command.

"lan -g" shows the gateway address. Make sure it is the address of your gateway if you are connecting from another subnet, 0.0.0.0 if you are connecting from the local subnet.

"lan -p" shows the port is 6470. If the port is not 6470, you must change it with the "lan -p 6470" command (unless you have deliberately set the port number to a different value because of a conflict).

---

## If you have LAN DLL errors

On a PC, the various LAN transport selections require the following DLLs:

- HP-ARPA
- WSOCKETS.DLL.
- Novell-WP
- WLIBSOCK.DLL.
- W4WG-TCP
- WSOCKETS.DLL. (Windows for Workgroups)
- WINSOCK1.1
- WINSOCK.DLL.

These DLLs are included with LAN software. The required DLL must be in your search path. This will be the case if your network software is installed.

---

## If the "POL" LED is lit

The "POL" LED indicates that the polarity is reversed on the receive pair if you are using a 10BASE-T connection. The HP E3490A Software Probe should still work properly in this situation, but other LAN devices may not work.

## If it takes a long time to connect to the network

- Check the subnet masks on the other LAN devices connected to your network. All of the devices should be configured to use the same subnet mask.

Subnet mask error messages do not indicate a major problem. You can continue using the HP E3490A Software Probe.

The HP E3490A Software Probe automatically sets its subnet mask based on the first subnet mask it detects on the network. If it then detects other subnet masks, it will generate error messages.

If there are many subnet masks in use on the local subnet, the HP E3490A Software Probe may take a very long time to connect to the network after it is turned on.

To "clean up" the network, connect a terminal to the HP E3490A Software Probe. You can then see error messages which will help you identify which devices on the network are using the wrong subnet masks.

---

## Problems with the Serial Interface

---

---

### If you cannot verify RS-232 communication

If the HP E3490A Software Probe prompt does not appear in the terminal emulator window:

- Make sure that you have connected the HP E3490A Software Probe to the proper power source and that the power light is lit.
- Make sure that you have properly configured the data communications switches on the HP E3490A Software Probe and the data communications parameters on the host computer. You should also verify that you are using the correct cable.

The most common type of data communications configuration problem involves the configuration of the HP E3490A Software Probe as a DTE device instead of as a DCE device. If you are using the wrong type of cable, no prompt will be displayed.

A cable with one-to-one connections will work with a PC or an HP Series 700 workstation.

---

### If you have RS-232 connection problems with the MS Windows Terminal program

- Remember that Windows 3.1 only allows two active RS-232 connections at a time. To be warned when you violate this restriction, choose Always Warn in the Device Contention group box under 386 Enhanced in the Control Panel.
- Use the "Terminal" program (usually found in the Accessories windows program group) and set up the "Communications..." settings as follows:

```
Baud Rate: 19200 (or whatever you have chosen for the
emulator)
Data Bits: 8
Parity: None
Flow Control: hardware
Stop Bits: 1
```

When you are connected, hit the Enter key. You should get a prompt back. If nothing echos back, check the switch settings on the HP E3490A Software Probe.

- If the switches are in the correct position and you still do not get a prompt when you hit return, try turning OFF the power to the HP E3490A Software Probe and turning it ON again.
- If you still don't get a prompt, make sure the RS-232 cable is connected to the correct port on your PC, and that the cable is appropriate for connecting the PC to a DCE device.

With certain RS-232 cards, connecting to an RS-232 port where the HP E3490A Software Probe is turned OFF (or is not connected) will hang the PC. The only way to get control back is to reboot the PC. Therefore, we recommend that you always turn ON the HP E3490A Software Probe before attempting to connect via RS-232.

---

## Problems with the N-Wire Connection

---

---

### If a user interface behaves erratically

- Check the orientation of the cable connecting the HP E3490A Software Probe to your target system. If the cable is offset or rotated, the HP E3490A Software Probe will try to interpret the "random" signals with unpredictable results. If the cable is rotated, the HP E3490A Software Probe or target system may also be damaged.
- Check that the processor clock speed has been properly configured. See page 46.
- If your target system uses a 68360, check that the FREEZE and CONFIG2 lines have sufficient pull-up current. See page 88 for more information.

---

## Problems with Configuration

---

### If you have problems displaying some registers

- If your user interface can read or write "generic" registers, but cannot access registers that are unique to your target microprocessor, check that the target microprocessor matches the processor type you have selected for your user interface. Use the configuration dialog in your user interface software to set the target processor type.
- If the value of the SP and PC are displayed as ???, see "If boot area accesses fail" on page 113.

---

### If you have problems initializing some registers

Some registers can only be written once after processor reset.

If you set the EMSIM values, then reset and break, the EMSIM values will be written to the SIM registers. If your initialization code then attempts to write to one of the "write once after reset" registers, the writes will fail.

If you are using the Real-Time C Debugger interface, use the **Execution→Run...From Reset** command to correctly execute the initialization code.

If you are using the Debugger/Emulator interface on a workstation, use the **Execution→Run→From Reset** command to correctly execute the initialization code.

---

## Problems with the Target System

---

---

### If boot area accesses fail

When you start a debugger interface or attempt to run from reset, the HP E3490A Software Probe makes four accesses to the target system boot area to find reset values for the SP and PC. It then attempts to read the values on the stack and the code at the PC.

This problem can result in unknown values for the SP and PC (displayed as ???) and can make the debugger interface respond very slowly.

To avoid this problem, you can do several things:

- Use the 10-pin connector. The extra two pins on this connector allow the HP E3490A Software Probe to complete unterminated memory cycles.
- In your boot-up code, set the initial PC and stack pointer to memory which will be accessible at reset. Be sure to set the chip selects appropriately.

---

### If the target system does not run

- Check that the CONFIG2 line is not floating. See page 88 (the "CONFIG2 pin" section in the "Designing a Target System" chapter) for more information.

---

## Problems with the HP E3490A Software Probe Itself

---

### To run the power up self test

- 1 Unplug the HP E3490A Software Probe, then plug it in.
- 2 Watch the status lights. They should show the following pattern:

○ = LED is off

● = LED is on

\* = Not applicable (LED is off or on)

---

#### Normal sequence during power up self test

---

	Pwr/Target LEDs	Meaning
1	●●●●	Initial power up, system reset
2	●○○○	XILINX array initialized successfully
3	●○○●	XILINX array tested successfully
4	●○○○	BOOT ROM space tested successfully
5	●○○●	GENERIC ROM space tested successfully
6	●○○○	DRIVER ROM space tested successfully
7	●○○●	RESERVED ROM space tested successfully
8	●○○○	RAM tested successfully
9	●●●●	LAN internal feedback tested successfully
10	●○○●	Start system, load drivers, initialize LAN

If the power up self test fails, the RESET LED will flash the number of the test, then stay lit.

If any of the LEDs fail to change, or all of them remain on, there is a system failure.

Following power up, the LEDs will enter one of the following states:

- No target system power, or HP E3490A Software Probe is not connected to the target system, or
- Target system is in a reset state
- Only the boot ROM was used; other firmware in the Flash EPROM has been corrupted

Starting a user interface will change the pattern to the one requested by the interface.

If the power up self tests fail, try the following:

- Check and reset the LAN address as shown in the "Connecting to the Host Computer" chapter. LAN powerup failures will occur if the HP E3490A Software Probe does not have a valid Link Level Address and IP Address.
- Disconnect all external connections, including the LAN, serial (RS-232), and BNC Break and Trigger cables, then cycle power.
- To ensure that the firmware is working as it should, reprogram the firmware, then cycle power.

## To execute the built-in performance verification test

In addition to the powerup tests, there are additional tests available through the built-in "terminal interface." Three of these tests can be invoked through either a telnet session to the HP E3490A Software Probe or through a terminal emulator on the RS-232 port. The LAN tests can only be executed through the RS-232 port.

The remainder of this section assumes that the tests are being run from a terminal emulator connected to the RS-232 port.

### 1 Set all of the switches to OPEN.

This is standard RS-232 at 9600 baud which can be connected directly to a 9 pin RS-232 interface that conforms to the IBM PC-AT 9 pin standard.

### 2 Use a terminal emulator to connect to the HP E3490A Software Probe.

### 3 Enter the **pv** command.

Solving Problems  
To execute the built-in performance verification test

Options available for the "pv" are explained in the help screen displayed by typing "help pv" or "? pv" at the prompt. The help screen output will appear similar to the screen shown below:

R>? pv

pv - Execute the system performance verification diagnostics.

USAGE: pv <-l> <-t\*|x[-y]> <-f> <-vverbose\_level> <repeat\_count>

pv - display pv warning message  
pv <-l> - list pv test#s and descriptions only (do not execute)  
pv <-t\*|x[-y]> - select pv test number x or tests x thru y only  
\* selects all emulation tests  
pv <-f> - for factory use only  
pv <-vverbose> - set verbose level; valid levels: 1-9.  
pv <repeat\_count> - execute diagnostics (repeat\_count) number of times.  
repeat\_count of 0 repeats until keyboard break

SETUP:

10BASE2 FEEDBACK TEST:  
Disconnect 10Base2 Connector From the Network  
Terminate With Two 50 Ohm Terminators on a TEE  
10BASET FEEDBACK TEST:  
Connect 10BaseT Connector To Active Port  
BREAK IN, TRIGGER OUT BNC FEEDBACK TEST:  
Connect Coaxial Cable Between BREAK IN and TRIGGER OUT  
TARGET PROBE FEEDBACK TEST:  
Replace Target Cable With Feedback Connector E3490-61604

WARNING\*\*\* This command performs a system initialization after  
all pv execution is completed.

R>

---

**Examples:**

To execute all tests one time:

pv 1

To execute test 2 with maximum debug output repeatedly until a ^C is entered:

pv -t2 -v9 0

To execute tests 3, 4, and 5 only for 2 cycles:

pv -t3-5 2

The tests available through this command can be displayed as follows:

```
R>pv -l
Tests Available in Performance Verification;
  Test # 1: Powerup PV Results
  Test # 2: LAN 10Base2 Feedback Test
  Test # 3: LAN 10BaseT Feedback Test
  Test # 4: Break In and Trigger Out BNC Feedback Test
  Test # 5: Target Probe Feedback Test
```

R>

On a good system, when the E3490-61604 feedback connector is plugged into the 20 pin target connector, the RESET LED will light and the BKG and USER LEDs will be out.

The results on a good system are as follows:

R>pv 1

```
Testing: HPE3499A Series Emulation System
  Test # 1: Powerup PV Results           passed!
  Test # 2: LAN 10Base2 Feedback Test    passed!
  Test # 3: LAN 10BaseT Feedback Test    passed!
  Test # 4: Break In and Trigger Out BNC Feedback Test passed!
  Test # 5: Target Probe Feedback Test   passed!
PASSED  Number of tests: 1              Number of failures: 0
```

Copyright (c) Hewlett-Packard Co. 1987  
All Rights Reserved. Reproduction, adaptation, or translation without prior written permission is prohibited, except as allowed under copyright laws.

```
HPE3499A Series Emulation System
Version:  A.05.00 29Aug94 15:53 Proto
Location:  Generics
```

```
HPE3490A Motorola CPU32 BDM Emulator
Version:  A.01.00 30Aug94 13:07 Proto
```

R>

There are some things you can do if a failure is found on one of these tests. Details of Failure can be obtained through using a verbose level of 2 or more.

### **TEST 2: LAN 10BASE2 Feedback Test**

For LAN 10BASE2 test, the following is an example of a failure which is *not* caused by a broken HP E3490A Software Probe.

Solving Problems  
To execute the built-in performance verification test

R>pv -t2 -v2 1

```
Testing: HPE3499A Series Emulation System
Test # 2: LAN 10Base2 Feedback Test          failed!
FAILED - no lan connection (LAN probably not terminated)
FAILED Number of tests: 1          Number of failures: 1
```

Check to see that the port under test has a good cable connected to it and that the cable is properly terminated with a 50 ohm terminator on each end of the overall cable.

R>pv -t2 -v2 1

```
Testing: HPE3499A Series Emulation System
Test # 2: LAN 10Base2 Feedback Test          failed!
FAILED due to excessive collisions
FAILED Number of tests: 1          Number of failures: 1
```

The most common cause of this problem is poor termination of the cable or failure to remove the port under test from the LAN before performing the test. Check to see that the terminators are good (50 Ohms) and that you are isolated from any traffic on a system LAN.

R>pv -t2 -v2 1

```
Testing: HPE3499A Series Emulation System
Test # 2: LAN 10Base2 Feedback Test          failed!
FAILED - invalid Ethernet address in EEPROM
FAILED Number of tests: 1          Number of failures: 1
```

First check to see that a correct LLA and IP address have been set in the virtual EEPROM through the "lan" command. If the "lan" command shows bad information for the LLA and IP, then try to set them to correct values. If you are unable to set them to correct values, there is a failure in the FLASH ROM which requires service from HP.

### Test 3: 10BaseT Feedback Test

R>pv -t3 -v2 1

```
Testing: HPE3499A Series Emulation System
Test # 3: LAN 10BaseT Feedback Test          passed!
PASSED Number of tests: 1          Number of failures: 0
```

In addition to the internal checks performed in Test 2, this test also checks for shorts on the cable connected to the network. If this test fails, disconnect the cable and run the test again. If it then passes, the cable is faulty. If it still fails, it requires service from HP.

If the HP E3490A Software Probe passes this "pv" test, additional testing can be performed through exercising the connection to the network. To run this test, set configuration switch 1 and switch 5 to OPEN, all other configuration switches CLOSED (this enables LAN using 10BaseT). Cycle power and wait for 15 to 30 seconds. Then "ping" the HP E3490A Software Probe from your host computer or PC. See the LAN documentation for your host computer for the location and action of the "ping" utility. If the HP E3490A Software Probe fails to respond to the "ping" request, verify that the lan parameters (IP address and gateway address) are set correctly and that your host computer recognizes the IP address of the HP E3490A Software Probe. If all else is good, then failure to respond to ping indicates a faulty HP E3490A Software Probe.

#### **TEST 4: Break In and Trigger Out BNC Feedback Test**

```
R>pv -t4 -v2 1
```

```
Testing: HPE3499A Series Emulation System
Test # 4: Break In and Trigger Out BNC Feedback Test    failed!
Break In not receiving Break Out HIGH
FAILED Number of tests: 1          Number of failures: 1
```

Before returning to HP, check to ensure that you have connected a good Coaxial cable between the two BNCs. If the cable is good, the E3490A is bad.

#### **TEST 5: Target Probe Feedback Test**

A verbose output on this test can be extensive. For example, the following is the output of this test if you forget to plug in the E3490-61604 connector.

```
p>pv -t5 -v2 1
```

```
Testing: HPE3499A Series Emulation System
Test # 5: Target Probe Feedback Test                    failed!
Bad 20 Pin Status Read when unconnected = 0x7fb7
Expected Value = 0xffb7
Bad 20 Pin Status Read when connected= 7fb7
Expected Value = 0x7fb7
Output 19 Low not received on Input 11
Output 11 Low not received on Input 19
Output 13 Low not received on Input 1
Output 12 High not received on Input 6
Output 12 and Input 6 not pulled high on release
Output 8 Low not received on Input 10
Output 7 Low not received on Input 20
```

## Solving Problems If the data in ROM is corrupt

```
Output 4 Low not received on Input 14
Output 2 Low not received on Input 18
FAILED Number of tests: 1          Number of failures: 1
```

If the you get a verbose output like this, check to make sure that the self test loopback connector was connected properly.

---

### If the data in ROM is corrupt

Sometimes the data in the FLASH ROM can be corrupt. This can be caused while programming of the FLASH ROM if one of the following things happens:

- A system fault
- A loss of power to the HP E3490A Software Probe or host computer
- A break in the communications channel

If this happens, try the following steps:

- 1 Cycle power on the HP E3490A Software Probe and try the flash programming utility (**progflash**) again.**

If this doesn't work, continue with the next step:

- 2 Set switch S3 to OPEN and switch S4 to CLOSED, then cycle power.**

This will force the HP E3490A Software Probe to use only the boot ROM. Try running the programming utility again. If this is successful, return the switches to their normal configuration (S3 and S4 OPEN) and cycle power.

---

## Returning the HP E3490A Software Probe to Hewlett-Packard for Service

---

### To return the HP E3490A Software Probe to Hewlett-Packard

- 1** Follow the procedures in this chapter to make sure that the problem is caused by a failure in the HP E3490A Software Probe or power supply, not by configuration or communication problems.
- 2** Call your nearest HP sales office. Ask them for the address of the nearest HP service center.

A list of HP sales offices is included at the back of this binder.

- 3** Package the HP E3490A Software Probe or the power supply and send it to the HP service center.

If only the HP E3490A Software Probe is broken, keep the power supply and cables. If only the power supply is broken, keep the HP E3490A Software Probe and cables.

- 4** When the HP E3490A Software Probe or the power supply has been replaced, it will be sent back to you.

The unit returned to you will have the same serial number as the unit you sent to HP.

---

## To obtain replacement cables

- Order one of the following parts from your HP sales office:

---

### Cable part numbers

---

<b>Part number</b>	<b>Description</b>
E3490-61601	8-pin BDM cable
E3490-61602	10-pin BDM cable
E3490-61603	10-pin flying lead assembly

A list of HP sales offices is included at the back of this manual.

---

## Glossary

**BDM** Background Debug Mode. An alternate operating mode of Motorola CPU32 microprocessors. BDM allows various debugging functions under external control.

allows you to communicate with the HP E3490A Software Probe.

**configuration** A set of parameters which control the operating modes and behavior of the HP E3490A Software Probe. Using your user interface software, you can create, modify, and save configurations as configuration files. A configuration must be applied to the HP E3490A Software Probe before it has any effect.

**IP address** Internet Protocol address. A 32-bit network address. It is usually represented as decimal numbers separated by periods; for example, 192.35.12.6. You must assign this address to the HP E3490A Software Probe.

**logical name** A name you make up for an HP E3490A Software Probe. You will use this name to identify the HP E3490A Software Probe whenever you start the user interface software. This name can be any easy to remember name, perhaps a unique name for the target or processor.

**user interface software** A program, such as a debugger, which runs on a host computer and which



64700tab.net file, 24–26

## A

address, IP

*See* IP address

algorithms, flash memory, 80

altitude specifications, 94

AUI connector on LAN interface, 9

## B

BKG light, 103

BNC, LAN, 9, 92

BOOTP, 16–17

bus cycle termination, 86

## C

cable

BDM, 29

LAN, 18

power, 8–9

replacing, 122

serial, 21–22

clock rate

reset, 31–32

clocks

specifications, 92–93

CONFIG2 line, 89

configuration

using Debugger/Emulato, 41–56

using RTC interface, 57–70

connecting to the host workstation, 3–26

connecting to the target system, 27–32

connection problems, LAN, 106

connection problems, RS-232, 109–110

connector

10BASE-T, 92

10BASE2, 92

BDM, 29

serial, 92

## D

data communications

specifications, 92

DCE or DTE selection and RS-232 cable,

109

DLL errors, 107

## E

EMSIM registers, 51–56, 66–70

erratic behavior, 111

ethernet address, 11

## F

files

64700tab.net, 24–26

workstation setup, 24

firmware version, 99

firmware, corrupt, 120

firmware, updating, 96

Flash EPROM, 96

flash memory

programming, 80, 82

supported parts, 80

## G

gateway, 106

gateway address, 12, 14–15

## H

HP 64700 LAN port number, 106

HP 64700 switch settings,

LAN, 106

RS-232, 109–110

HP-ARPA LAN transport DLL, 107

humidity specifications, 94

## I

IEEE 802.3, 9

interfaces, 36

internet address

*See* IP address

IP address, 9–11, 14–15, 105–106

ipconfig700, 14–15

## L

LAN connection problems, 106, 117–118

LAN interface, 9

LAN parameters, configuring, 9

BOOTP, 16–17

ipconfig700, 14–15

terminal interface, 11–13

lights

*See* status lights

link beat, 18

link level address, 11, 15, 17

LINK light, 103

## M

mask, subnet, 108

MAU, 9, 92

## N

Novell LAN transport DLL, 107

## O

order

update, 97

## P

performance verification test, 115–119

ping command, 106

POL light, 103, 107

port number, 12

power cord, 5, 8–9

power failure during firmware update, 100

power up self test, 114

probe, testing, 119

processor type, setting, 45, 60

progflash, 96

## R

registers

EMSIM, 51–56, 66–70

initializing, 112

problems displaying, 112–113

unknown values, 113

RESET light, 103

restriction on number of RS-232

connections, 109–110

RS-232

*See* serial connection

---

## S

- search path, 107
- self test, 114
- serial connection
  - DCE or DTE selection, 109
  - number of connections, 109–110
  - problems, 109–110
  - setting up, 20
  - verifying, 23
- service ports, TCP, 12
- service, how to obtain, 121
- software material subscription (SMS), 97
- software updates, 97
- specifications
  - altitude, 94
  - clock, 92–93
  - data communications, 92
  - humidity, 94
  - temperature, 94
  - trigger in/out, 92
- StarLAN, 9, 18
- status lights, 104, 114
- subnet mask, 9, 106, 108
- switches
  - bootp, 17
  - serial configuration, 21

## T

- target system
  - connecting to, 28
- telnet, 19, 105
- temperature specifications, 94
- terminal (MS Windows program), 109–110
- terminal interface, 19
  - LAN parameters, setting, 11–13
  - not supported, 36
- ThickLAN, 9
- ThinLAN, 9, 92
- trigger
  - in/out specifications, 92
- turning on power, 8–9
- TX light, 103

## U

- update
  - firmware, procedure, 98
- update, firmware, 96
- USER light, 103

## V

- version, firmware, 99
- voltage
  - processor, 92

## W

- Windows for Workgroups LAN transport DLL, 107
- WINSOCK LAN transport DLL, 107
- WINSOCK.DLL, 107
- WLIBSOCK.DLL, 107
- workstation files, 24
- WSOCKETS.DLL, 107

# DECLARATION OF CONFORMITY

according to ISO/IEC Guide 22 and EN 45014

**Manufacturer's Name:** Hewlett-Packard Company  
**Manufacturer's Address:** Colorado Springs Division  
1900 Garden of the Gods Road  
Colorado Springs, CO 80907 U.S.A.

declares, that the product

**Product Name:** Software Probe  
**Model Number(s):** E3490A  
**Product Option(s):** All

conforms to the following Product Specifications:

**Safety:** IEC 1010-1:1990+AMD 1:1992  
UL 3111

**EMC:** CISPR 11:1990 / EN 55011:1991      Group 1 Class A  
IEC 801-2:1991 / EN 50082-1:1992      4 kV CD, 8 kV AD  
IEC 801-3:1984 / EN 50082-1:1992      3 V/m, {1kHz 80% AM, 27-1000 MHz}  
IEC 801-4:1988 / EN 50082-1:1992      0.5 kV Sig. Lines, 1 kV Power Lines

## Supplementary Information:

The product herewith complies with the requirements of the Low Voltage Directive 73/23/EEC and the EMC Directive 89/336/EEC.

Colorado Springs, 6/15/94

  
John Strathman, Quality Manager

European Contact: Your local Hewlett-Packard Sales and Service Office or Hewlett-Packard GmbH, Department ZQ / Standards Europe, Herrenberger Strasse 130, D-71034 Böblingen Germany (FAX: +49-7031-14-3143)

## Product Regulations

**Safety** IEC 1010-1:1990+AMD 1:1992  
UL 3111

**EMC** This product meets the requirement of the European Communities (EC) EMC Directive 89/336/EEC.

**Emissions** EN55011/CISPR 11 (ISM, Group 1, Class A equipment)  
SABS RAA Act No. 24 (1990)

**Immunity** EN50082-1

	Code <sup>1</sup>	Notes <sup>2</sup>
--	-------------------	--------------------

IEC 801-2 (ESD) 4kV CD, 8kV AD	3	
--------------------------------	---	--

IEC 801-3 (Rad.) 3 V/m	1	
------------------------	---	--

IEC 801-4 (EFT) 1kV	1	
---------------------	---	--

---

<sup>1</sup> Performance Codes:

1 PASS - Normal operation, no effect.

2 PASS - Temporary degradation, self recoverable.

3 PASS - Temporary degradation, operator intervention required.

4 FAIL - Not recoverable, component damage.

---

<sup>2</sup> Notes:

(none)

© Copyright Hewlett-Packard Company 1994, 1995  
All Rights Reserved.

Reproduction, adaptation, or translation without prior written permission is prohibited, except as allowed under the copyright laws.

### Restricted Rights Legend

Use, duplication, or disclosure by the U.S. Government is subject to restrictions set forth in subparagraph (C) (1) (ii) of the Rights in Technical Data and Computer Software Clause in DFARS

252.227-7013.

Hewlett-Packard Company,  
3000 Hanover Street, Palo Alto, CA 94304 U.S.A.

Rights for non-DOD U.S. Government Departments and Agencies are set forth in FAR 52.227-19(c)(1,2).

### Document Warranty

The information contained in this document is subject to change without notice.

**Hewlett-Packard makes no warranty of any kind with regard to this material, including, but not limited to, the implied warranties of merchantability or fitness for a particular purpose.**

Hewlett-Packard shall not be liable for errors contained herein or for damages in connection with the furnishing, performance, or use of this material.

### Safety

This apparatus has been designed and tested in accordance with IEC Publication 348, Safety Requirements for Measuring Apparatus, and has been supplied in a safe condition. This is a Safety Class I instrument (provided with terminal for protective earthing). Before applying power, verify that the correct safety precautions are taken (see the following warnings). In addition, note the external markings on the instrument that are described under "Safety Symbols."

### Warning

- Before turning on the instrument, you must connect the protective earth terminal of the instrument to the protective conductor of the (mains) power cord. The mains plug shall only be inserted in a socket outlet provided with a protective earth contact. You must not negate the protective action by using an extension cord (power cable) without a protective conductor (grounding). Grounding one conductor of a two-conductor outlet is not sufficient protection.
- Only fuses with the required rated current, voltage, and specified type (normal blow, time delay, etc.) should be used. Do not use repaired fuses or short-circuited fuseholders. To do so could cause a shock of fire hazard.

- Service instructions are for trained service personnel. To avoid dangerous electric shock, do not perform any service unless qualified to do so. Do not attempt internal service or adjustment unless another person, capable of rendering first aid and resuscitation, is present.
- If you energize this instrument by an auto transformer (for voltage reduction), make sure the common terminal is connected to the earth terminal of the power source.
- Whenever it is likely that the ground protection is impaired, you must make the instrument inoperative and secure it against any unintended operation.
- Do not operate the instrument in the presence of flammable gasses or fumes. Operation of any electrical instrument in such an environment constitutes a definite safety hazard.
- Do not install substitute parts or perform any unauthorized modification to the instrument.
- Capacitors inside the instrument may retain a charge even if the instrument is disconnected from its source of supply.

### Safety Symbols



Instruction manual symbol: the product is marked with this symbol when it is necessary for you to refer to the instruction manual in order to protect against damage to the product.



Hazardous voltage symbol.



Earth terminal symbol: Used to indicate a circuit common connected to grounded chassis.

### WARNING

The Warning sign denotes a hazard. It calls attention to a procedure, practice, or the like, which, if not correctly performed or adhered to, could result in personal injury. Do not proceed beyond a Warning sign until the indicated conditions are fully understood and met.

### CAUTION

The Caution sign denotes a hazard. It calls attention to an operating procedure, practice, or the like, which, if not correctly performed or adhered to, could result in damage to or destruction of part or all of the product. Do not proceed beyond a Caution symbol until the indicated conditions are fully understood or met.

---

**Product Warranty**

This Hewlett-Packard product has a warranty against defects in material and workmanship for a period of one year from date of shipment. During the warranty period, Hewlett-Packard Company will, at its option, either repair or replace products that prove to be defective.

For warranty service or repair, this product must be returned to a service facility designated by Hewlett-Packard.

For products returned to Hewlett-Packard for warranty service, the Buyer shall prepay shipping charges to Hewlett-Packard and Hewlett-Packard shall pay shipping charges to return the product to the Buyer. However, the Buyer shall pay all shipping charges, duties, and taxes for products returned to Hewlett-Packard from another country.

Hewlett-Packard warrants that its software and firmware designated by Hewlett-Packard for use with an instrument will execute its programming instructions when properly installed on that instrument.

Hewlett-Packard does not warrant that the operation of the instrument software, or firmware will be uninterrupted or error free.

**Limitation of Warranty**

The foregoing warranty shall not apply to defects resulting from improper or inadequate maintenance by the Buyer, Buyer-supplied software or interfacing, unauthorized modification or misuse, operation outside of the environmental specifications for the product, or improper site preparation or maintenance.

**No other warranty is expressed or implied. Hewlett-Packard specifically disclaims the implied warranties of merchantability or fitness for a particular purpose.**

**Exclusive Remedies**

The remedies provided herein are the buyer's sole and exclusive remedies.

Hewlett-Packard shall not be liable for any direct, indirect, special, incidental, or consequential damages, whether based on contract, tort, or any other legal theory.

**Assistance**

Product maintenance agreements and other customer assistance agreements are available for Hewlett-Packard products.

For any assistance, contact your nearest Hewlett-Packard Sales Office.

**Certification**

Hewlett-Packard Company certifies that this product met its published specifications at the time of shipment from the factory. Hewlett-Packard further certifies that its calibration measurements are traceable to the United States National Institute of Standards and Technology, to the extent allowed by the Institute's calibration facility, and to the calibration facilities of other International Standards Organization members.

**About this edition**

This is the second edition of the *HP E3490A Software Probe User's Guide*.

Publication number  
E3490-97002

Printed in USA.

Edition dates are as follows:

First edition, Oct 1994

Second edition, Nov 1994

Third edition, July 1995

New editions are complete revisions of the manual. Many product updates do not require manual changes, and manual corrections may be done without accompanying product changes. Therefore, do not expect a one-to-one correspondence between product updates and manual updates.

UNIX is a registered trademark in the United States and other countries, licensed exclusively through X/Open Company Limited.